



Stainless Steel **Tube, Pipe**
& **Fittings**





One Trusted Source - Worldwide

If ever there were industries with a low tolerance for imperfection, they would be the semiconductor, TFT/LCD, and solar industries. At Valex, these are our customers. As manufacturing processes grow more precise, our customers' needs for stainless steel piping systems evolve to ever more demanding levels of cleanliness, leak integrity, corrosion resistance, and surface finish. A consistent and reliable source for the highest quality components and assemblies is essential for their success.

For over four decades, Valex has been the leading manufacturer of stainless steel tube, fittings, valves, and assemblies that allow our customers to meet their construction schedules and yield goals. Along the way, we've introduced the most important advances in fittings design, electropolishing, precision cleaning, and integrated assemblies. With three manufacturing plants, each strategically located in major markets, Valex offers the largest capacity of any supplier. We are the only manufacturer of the full size range of products used by global customers - inch sizes and JIS sizes - all under Valex control.

Our unrivaled experience, in-house capacity, unmatched product breadth, and singular focus on only the most demanding industries have led customers around the world to the same conclusion - Valex is their **one trusted source**.



Product Lines	
Valex Product Line Specifications.....	4
Quality	
Quality Assurance & Testing Capability.....	14
Process	
Production Process	15
Tube & Pipe	
Dimensional Charts.....	20
Elbows	
Dimensional Charts.....	25
Tees	
Dimensional Charts.....	35
Crosses	
Dimensional Charts.....	50
Reducers	
Dimensional Charts.....	52
End Caps	
Dimensional Charts.....	67
Stub Ends	
Dimensional Charts.....	70
Flanges	
Dimensional Charts.....	75
Coaxial Tube & Fittings	
Usage Information & Dimensional Charts.....	85
Ordering Information	
For All Valox Product Lines.....	94

* Dimensional charts are subject to change. Please visit Valex.com or call your local Valox representative for the latest information.

Product Lines

Ultra High Purity,
Electropolished

- 401
- 301
- LDEP

Cleaned for
Oxygen Service

- 201
- 101
- CFOS

Hasteloy® C-22® Alloy*

- 222

LDEP

CFOS

301

401

201

101

222

Product Line Selector

Does the process use electropolished or non-electropolished product?

Start

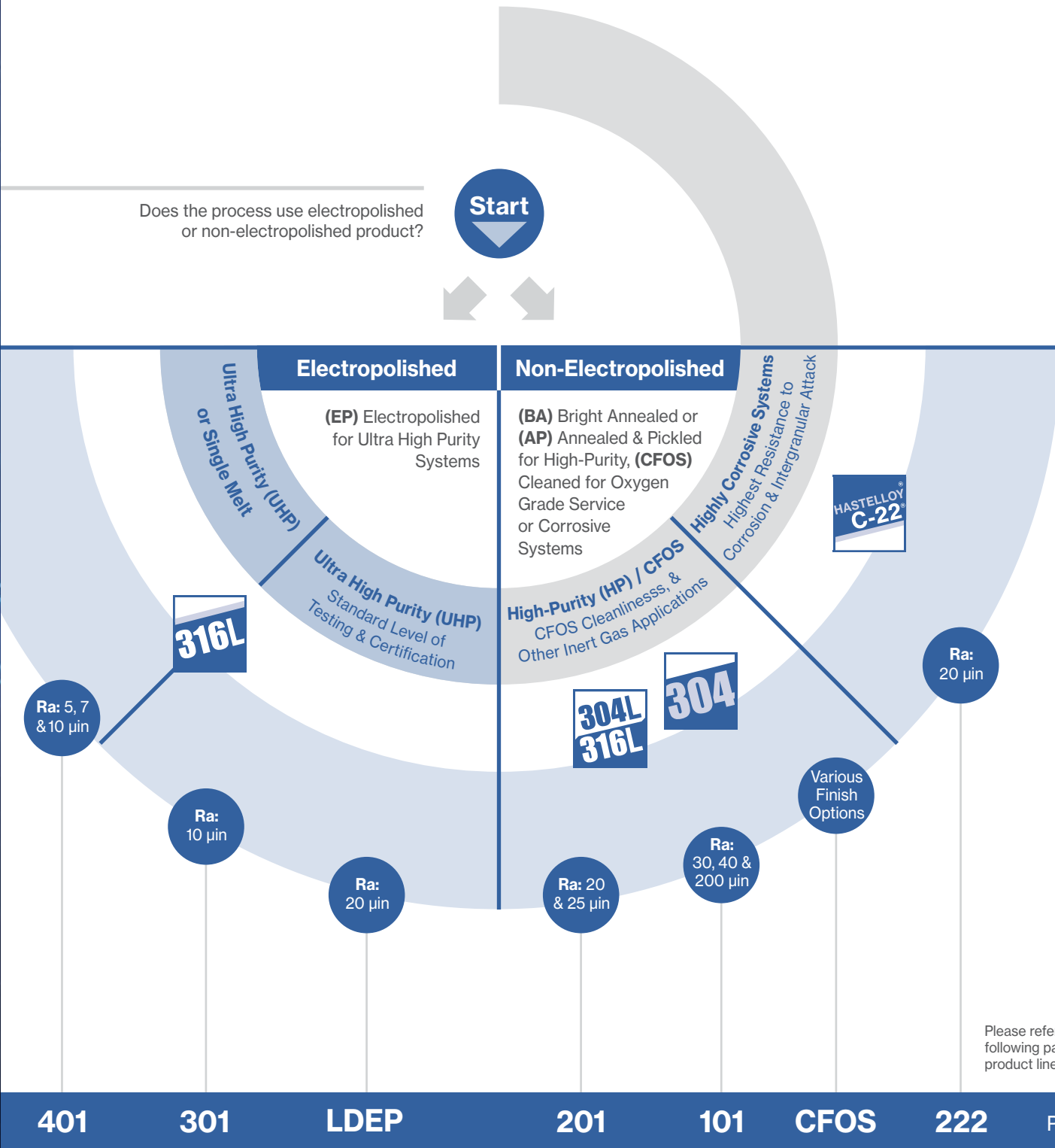

Please refer to the following pages for additional product line information.

401 301 LDEP 201 101 CFOS 222 Product Lines

* Hastelloy and C-22 are registered trademarks of Haynes International Inc.

401

Product Line



Valex Specification SP-9220

Applications

Ultra High Purity Systems requiring the highest grade of materials and certifications, Electropolished

Alloy

316L Stainless steel, single-melt or double-melt (seamless or welded, depending on size)

Sizes

ASTM Tube: 1/8" to 6"

ASTM Fittings: 1/4" to 6"

JIS Pipe: 8A to 300A

I.D. Surface Finish Options

A5: 5 µin Ra max

A7: 7 µin Ra max

BO: 10 µin Ra max

CO: 10 µin Ra

Tolerances

In accordance with ASTM: A 269, A 632 & JIS: G 3459

Weld Ends

Tube: Square ends suitable for orbital welding

Pipe: Square or beveled end options

Testing & Inspection

- Visual inspection
- Surface roughness measurement
- Helium-leak testing
- Scanning Electron Microscopy (SEM)
- Auger Electron Microscopy (AES)

- Election Spectroscopy for Chemical Analysis (ESCA or XPS)
- Particle testing
- Moisture testing

Marking & Traceability

Each component is traceable to its producing mill and heat by an identification number etched within 24" (610mm) of one end.

Labeling

Each component's bag is affixed with a label identifying the component's part number, date and Valex lot number.

Documentation

A quality inspection certificate is furnished with each shipment. The report contains the following information:

- Material composition & applicable specification designation
- Nominal outside diameter size
- Chemical composition
- Statement of quality assurance testing
- Inspection Certificate type 3.1 per EN 10204:2004
- Lot & heat identification for traceability

Packaging

All components are purged with UHP nitrogen, capped, double-bagged and packaged for shipment in such a manner, which prevents damage to product and primary product packaging.



301

Product Line

Valex Specification SP-9223

Applications

Ultra High Purity Systems, Electropolished

Alloy

316L Stainless steel, single-melt
(seamless or welded, depending on size)

Sizes

ASTM Tube: 1/8" to 6"

I.D. Surface Finish

10 μ m Ra

Tolerances

In accordance with ASTM: A 269 & A 632

Weld Ends

Square ends are suitable for orbital welding

Testing & Inspection

- Visual inspection
- Surface roughness measurement
- Dimensional inspection

Marking & Traceability

Each component is traceable to its producing mill and heat by an identification number etched within 24" (610mm) of one end.

Labeling

Each component's bag is affixed with a label identifying the component's part number, date and Valox lot number.

Documentation

A quality inspection certificate is furnished with each shipment. The report contains the following information:

- Material composition & applicable specification designation
- Nominal outside diameter size
- Chemical composition
- Statement of quality assurance testing
- Inspection Certificate type 3.1 per EN 10204:2004
- Lot & heat identification for traceability

Packaging

All components are purged with UHP nitrogen, capped, double-bagged and packaged for shipment in such a manner, which prevents damage to product and primary product packaging.



LDEP

Product Line

Valex Specification SP-9235

Applications

Ultra High Purity Systems, Electropolished

Alloy

316L Stainless steel, single-melt
(seamless or welded, depending on size)

Sizes

JIS Pipe: 25A to 600A
ASTM/ASME Pipe: NPS 2 to NPS 12

I.D. Surface Finish

20 μ m Ra average, 25 μ m Ra max

Tolerances

In accordance with applicable ASTM,
ASME & JIS specifications

Weld Ends

Square or beveled end options

Testing & Inspection

- Visual inspection
- Surface roughness measurement
- Dimensional inspection

Marking & Traceability

Each component is traceable to its producing mill and heat by an identification number etched within 24" (610mm) of one end.

Labeling

Each component's bag is affixed with a label identifying the component's part number, date and Valox lot number.

Documentation

A quality inspection certificate is furnished with each shipment. The report contains the following information:

- Material composition & applicable specification designation
- Nominal outside diameter size
- Chemical composition
- Statement of quality assurance testing
- Inspection Certificate type 3.1 per EN 10204:2004
- Lot & heat identification for traceability

Packaging

All components are capped, bagged and packaged for shipment in such a manner, which prevents damage to product and primary product packaging.



201

Product Line

Valex Specification SP-9206

Applications

High-Purity Systems

Alloy

316L, 304L, or 304 Stainless steel, single-melt (seamless or welded, depending on size)

Sizes

ASTM Tube: 1/8" to 6"

ASTM Fittings: 1/4" to 6"

JIS Pipe & Fittings: 15A to 600A

I.D. Surface Finish

ASTM Tube: 25 µin Ra max

ASTM Tube Fittings: 20 µin Ra max

JIS Pipe: 25 µin Ra max

JIS Pipe Fittings: 25 µin Ra max

Tolerances

In accordance with ASTM: A 269 & A 632

JIS: G 3459 & G 3468

Weld Ends

Tube: Square ends suitable for orbital welding

Pipe: Square or beveled end options

Testing & Inspection

- Visual inspection
- Surface roughness measurement

- Helium-leak testing
- Dimensional inspection

Marking & Traceability

Each component is traceable to its producing mill and heat by an identification number etched within 24" (610mm) of one end.

Labeling

Each component's bag is affixed with a label identifying the component's part number, date and Valox lot number.

Documentation

A quality inspection certificate is furnished with each shipment. The report contains the following information:

- Material composition & applicable specification designation
- Nominal outside diameter size
- Chemical composition
- Statement of quality assurance testing
- Inspection Certificate type 3.1 per EN 10204:2004
- Lot & heat identification for traceability

Packaging

All components are capped, bagged and packaged for shipment in such a manner, which prevents damage to product and primary product packaging.



101

Product Line

Valex Specification SP-9204

Applications

High-Purity Systems

Alloy

316L, 304L, or 304 Stainless steel, single-melt (seamless or welded, depending on size)

Sizes

ASTM Tube: $\frac{1}{8}$ " to 6"

JIS Pipe: 15A to 600A

I.D. Surface Finish

ASTM Tube: $\frac{1}{8}$ " to 4" = 30 $\mu\text{in Ra}$
6" = 200 $\mu\text{in Ra}$

JIS Pipe: 15A to 100A = 40 $\mu\text{in Ra}$
125A to 600A = 200 $\mu\text{in Ra}$

Tolerances

In accordance with ASTM: A 269 & A 632,
JIS: G 3459 & G 3468

Weld Ends

Tube: Square ends suitable for orbital welding

Pipe: Square or beveled end options

Testing & Inspection

- Visual inspection
- Surface roughness measurement
- Dimensional inspection

Marking & Traceability

Each component is traceable to its producing mill and heat by an identification number etched within 24" (610mm) of one end.

Labeling

Each component's bag is affixed with a label identifying the component's part number, date and Valox lot number.

Documentation

A quality inspection certificate is furnished with each shipment. The report contains the following information:

- Material composition & applicable specification designation
- Nominal outside diameter size
- Chemical composition
- Statement of quality assurance testing
- Inspection Certificate type 3.1 per EN 10204:2004
- Lot & heat identification for traceability

Packaging

All components are capped, bagged and packaged for shipment in such a manner, which prevents damage to product and primary product packaging.



CFOS

Product Line

Valex Specification SP-9234

Applications

High Purity Systems

Alloy

316L, 304L, or 304 Stainless steel, single-melt (seamless or welded, depending on size)

Sizes

ASTM Tube & Fittings: 1/4" to 6"

JIS Pipe: 25A to 750A

JIS Fittings: 15A to 600A

ASTM/ASME Pipe: NPS 2 to NPS 30

ASTM/ASME Fittings: NPS 1/2 to NPS 24

I.D. Surface Finish Options

AP: Annealed & pickled

ID40: 40 µin Ra Internal finish

IDMP: Mechanically polished

BA: Bright annealed

BA40: Bright annealed with 40 µin Ra internal finish

Tolerances

In accordance with ASTM, ASME & JIS specifications

Weld Ends

Tube: Square ends suitable for orbital welding

Pipe: Square or beveled end options

Testing & Inspection

- Visual inspection

- Surface roughness measurement
- Dimensional inspection

Marking & Traceability

Each component is traceable to its producing mill and heat by an identification number etched within 24" (610mm) of one end.

Labeling

Each component's bag is affixed with a label identifying the component's part number, date and Valex lot number.

Documentation

A quality inspection certificate is furnished with each shipment. The report contains the following information:

- Material composition & applicable specification designation
- Nominal outside diameter size
- Chemical composition
- Statement of quality assurance testing
- Inspection Certificate type 3.1 per EN 10204:2004
- Lot & heat identification for traceability

Packaging

Packaged for shipment in such a manner, which prevents damage to product and primary product packaging.



222

Product Line

Valex Specification SP-9207

Applications

Extremely corrosive systems

Alloy

Nickel-Chromium-Molybdenum-Tungsten Alloy
Haynes Hastelloy® C-22®*

Sizes

ASTM Tube: 1/4" to 1/2"

I.D. Surface Finish

20 µin Ra max

Tolerances

Outside diameter: ± 0.005 "
Wall thickness: $\pm 12.5\%$

Weld Ends

Square ends suitable for orbital welding

Testing & Inspection

- Visual inspection
- Surface roughness measurement
- Fittings leak test
- Dimensional inspection

Marking & Traceability

Each component is traceable to its producing mill and heat by an identification number etched within 24" (610mm) of one end.

Labeling

Each component's bag is affixed with a label identifying the component's part number, date and Valox lot number.

Documentation

A quality inspection certificate is furnished with each shipment. The report contains the following information:

- Material composition & applicable specification designation
- Nominal outside diameter size
- Chemical composition
- Statement of quality assurance testing
- Inspection Certificate type 3.1 per EN 10204:2004
- Lot & heat identification for traceability

Packaging

All components are purged with UHP nitrogen, capped, bagged and packaged for shipment in such a manner, which prevents damage to product and primary product packaging.

* Hastelloy and C-22 are registered trademarks of Haynes International Inc.



Coaxial

Product Line

Valex Specification SP-9222

Applications

Contingent upon customers specifications

Alloy

316L, 304L, or 304 Stainless steel,
(Tubing & sleeves are seamless or welded,
depending on customers specifications)

Sizes

ASTM Tube:

.250" x .500"	.500" x .750"	1.00" x 1.25"
.375" x .625"	.750" x 1.00"	1.50" x 2.00"

I.D. Surface Finish Options

A5: 5 μ m Ra max

A7: 7 μ m Ra max

B0: 10 μ m Ra max

C0: 10 μ m Ra

Tolerances

In accordance with ASTM: A 269 & A 632

Weld Ends

Square ends suitable for orbital welding

Testing & Inspection

Outer Tube:

- Visual Inspection
- Dimensional Inspection
- Outer Tube Leak Testing

Inner Tube:

- Per Valox Specification: SP-9204, SP-9206, SP-9207, SP-9220, or SP-9223

Marking & Traceability

Each component is traceable to its producing mill and heat by an identification number.

Labeling

Each component's bag is affixed with a label identifying the component's part number, date and Valox lot number.

Documentation

A quality inspection certificate for the inner tube is furnished with each shipment. The report contains the following information:

- Material composition & applicable specification designation
- Nominal outside diameter size
- Chemical composition
- Statement of quality assurance testing
- Inspection Certificate type 3.1 per EN 10204:2004
- Lot & heat identification for traceability

Packaging

Assembled product packaged per applicable specification.

Quality



Tested Beyond the Standard

Product testing and certification are in strict accordance with industry-leading Valex specifications. Going well beyond our own requirements, we have brought sophisticated testing technology in-house, including a Scanning Electron Microscope (SEM) to assure electropolish quality and metallurgical integrity, as well as X-ray Fluorescence (XRF) spectroscopy equipment to verify elemental composition of the stainless steel. These, and many other steps unique to us, add unmatched levels of control that assure Valex products not only meet, but exceed specifications and customer expectations.



Process

Processed for Success

Continued refinement and advancement is the inevitable progression for Valex-designed manufacturing equipment and processes. Over the years, these developments have resulted in the largest range of choice for size and surface finish options of ASTM, ASME, and JIS components available to our customers.

All of our products conform to identical Valex specifications, using the same proven processes and equipment at each of our three manufacturing facilities. Each facility consistently manufactures product exceeding performance requirements, while creating and maintaining Ultra High Purity using ISO Class 5 clean rooms with semiconductor-quality deionized water and nitrogen – assuring the highest levels of product integrity and performance.

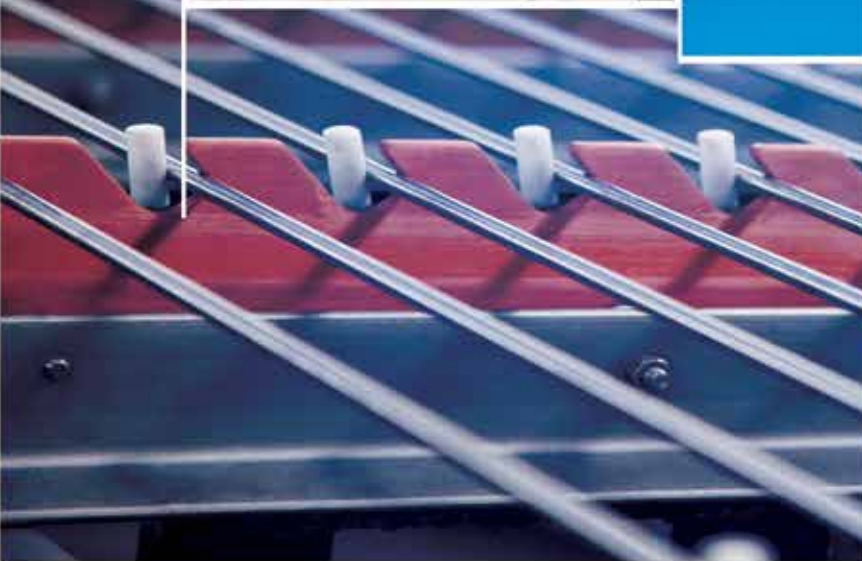



Tube & Pipe Process

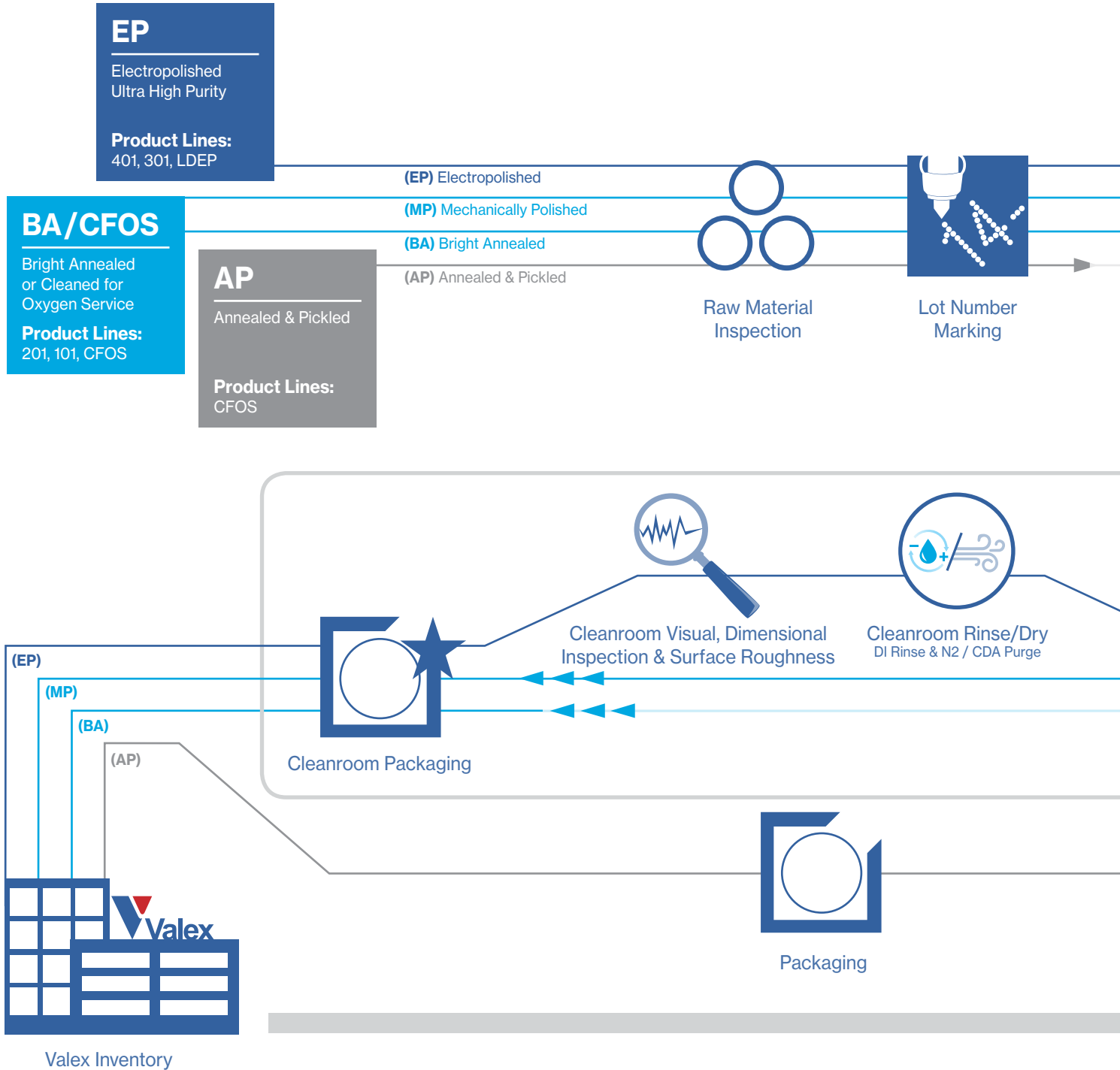

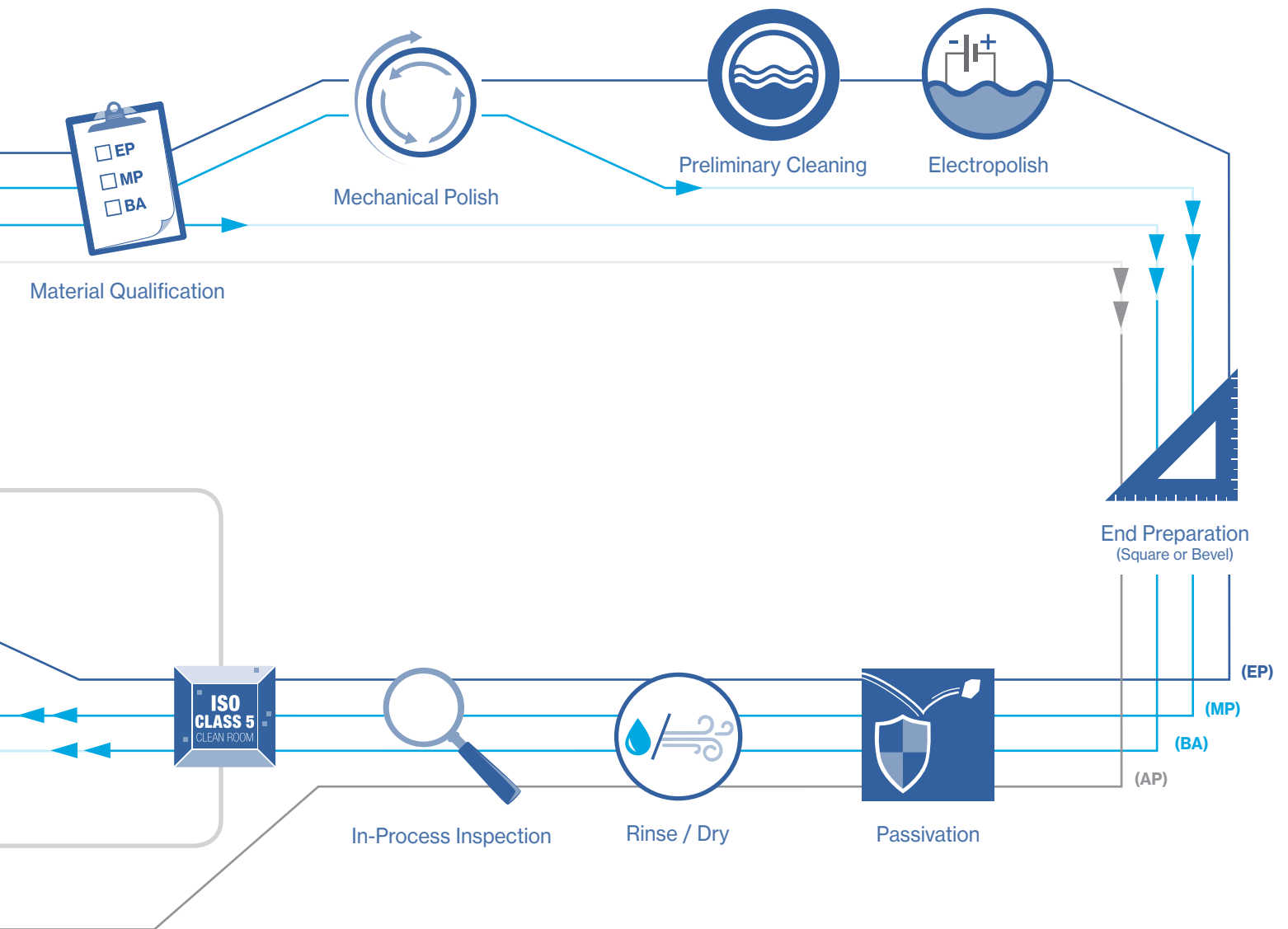



Fittings Process

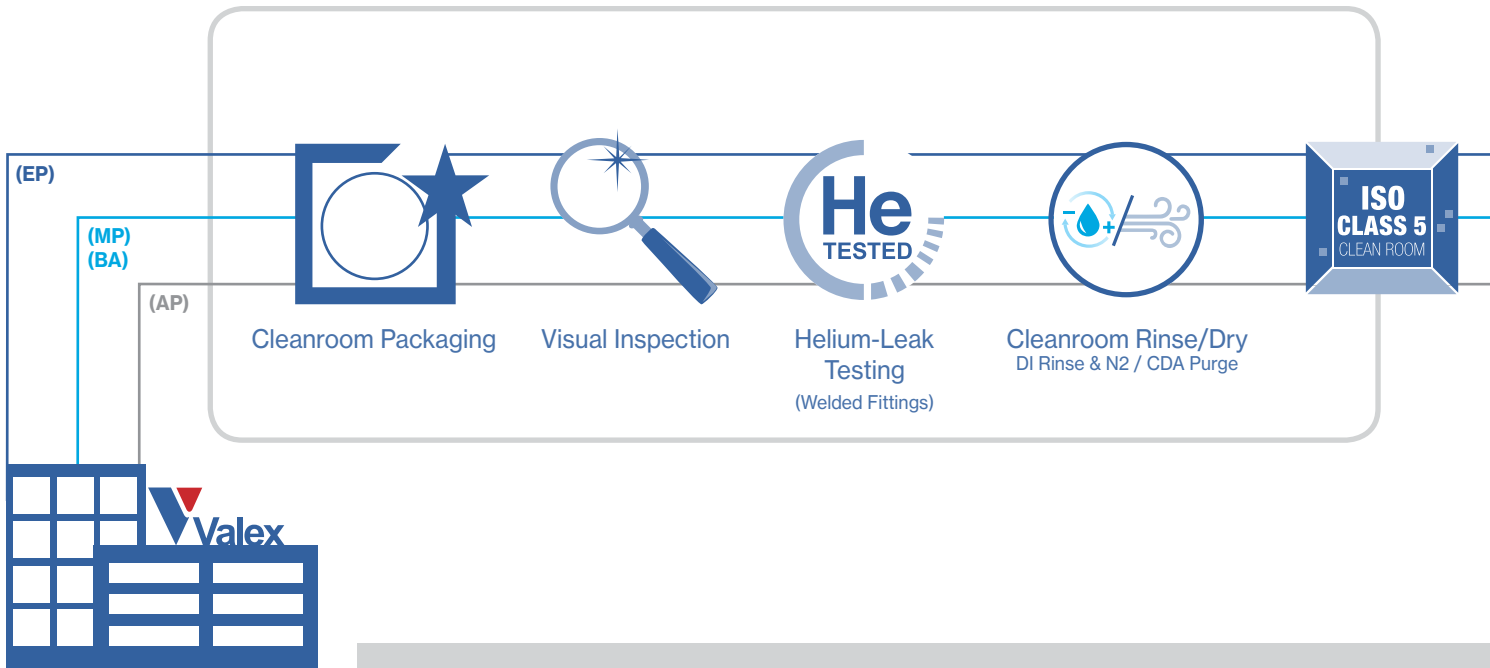
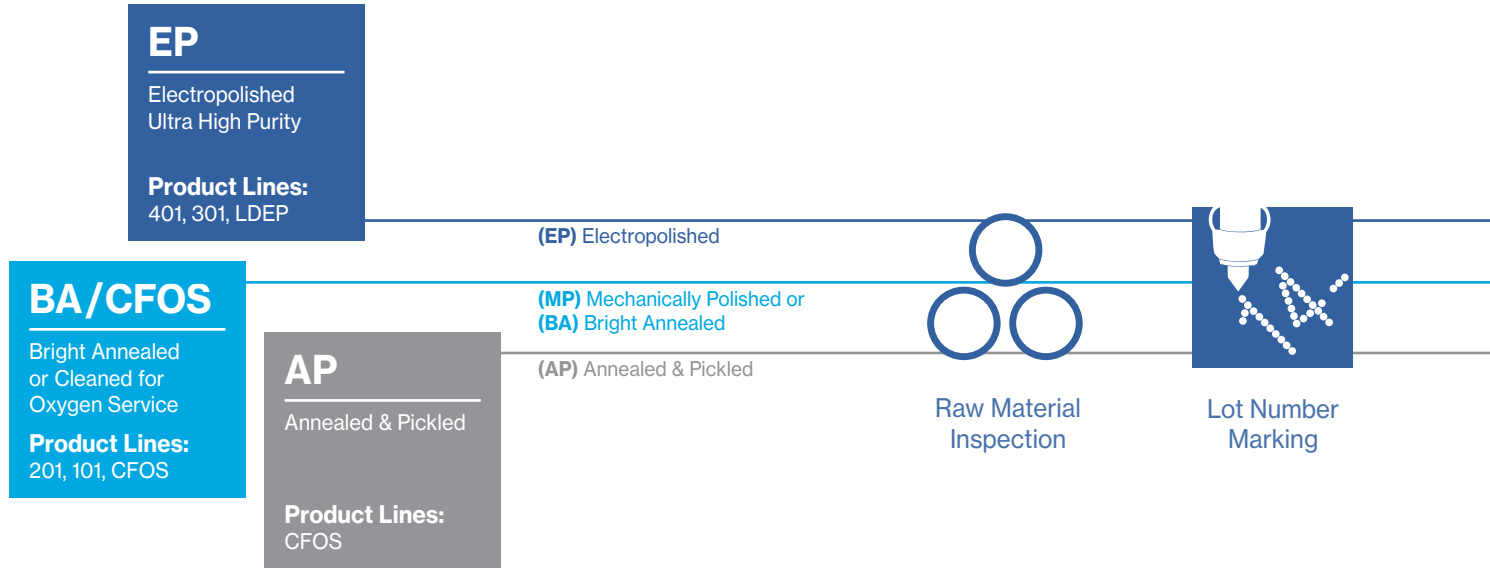

Valex Inventory

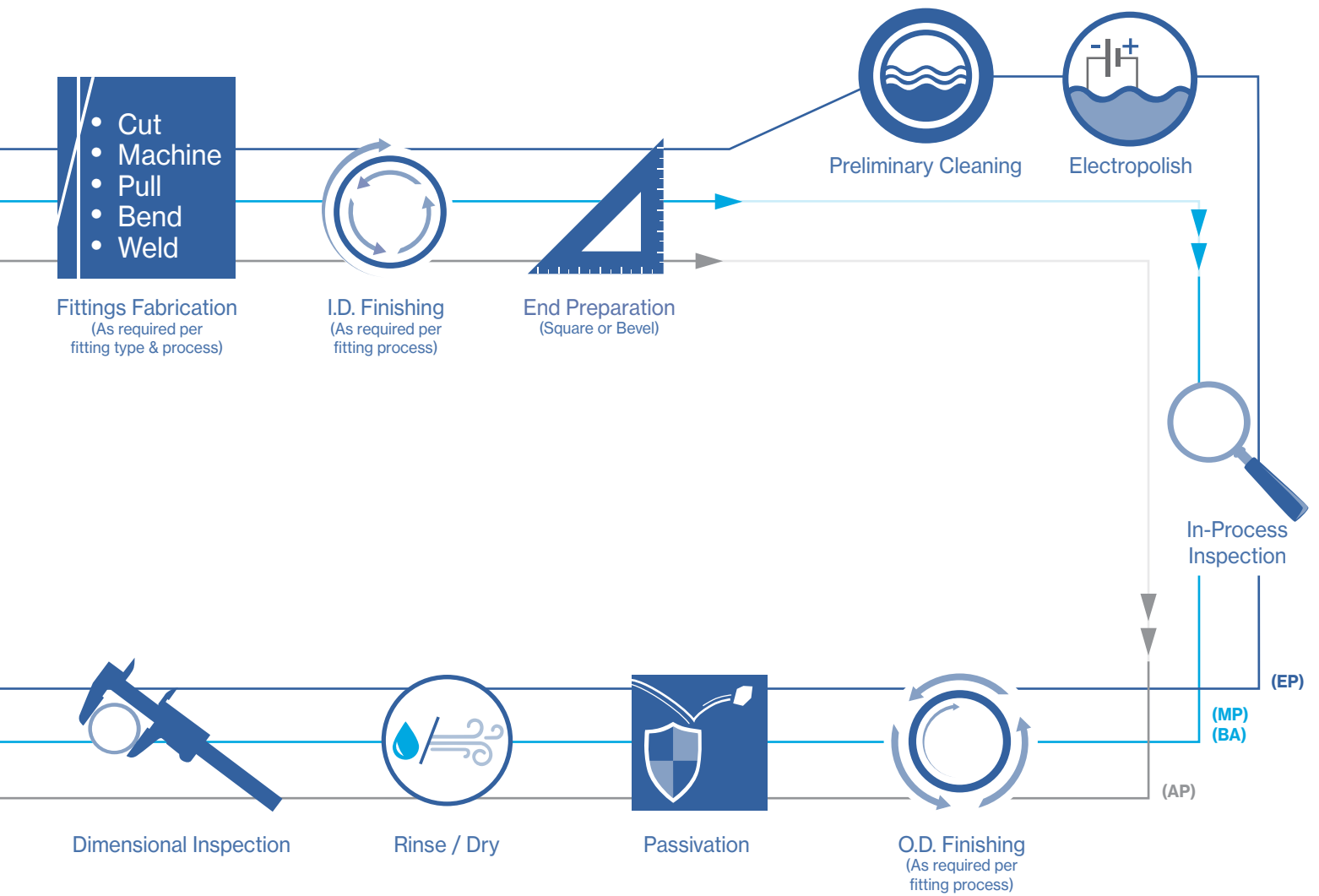

Tube & Pipe



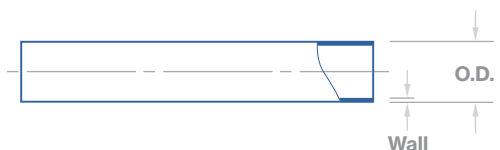

Tube

ASTM A269 / A632

Product Lines					Dimensions in Inches							
401	301	201	101	CFOS	Size	O.D.	Wall	Weight per foot (lbs.)	Maximum Safe Working Pressure*			
									PSI Seamless	PSI Welded	Bar Seamless	Bar Welded
●	●	●	●		1/8"	.125	.028	.03	7,805	N/A	538	N/A
●	●	●	●	●	1/4"	.250	.035	.08	4,598	N/A	317	N/A
●	●	●	●	●	1/4"	.250	.039	.09	5,189	N/A	358	N/A
●	●	●	●	●	3/8"	.375	.035	.13	2,974	N/A	205	N/A
●	●	●	●	●	3/8"	.375	.039	.14	3,341	N/A	230	N/A
●	●	●	●	●	1/2"	.500	.049	.24	3,136	2,509	216	173
●	●	●	●	●	3/4"	.750	.065	.48	2,759	2,207	190	152
●	●	●	●	●	1"	1.000	.065	.65	2,039	1,631	141	113
●	●	●	●	●	1-1/2"	1.500	.065	1.00	1,340	1,072	92	74
●	●	●	●	●	2"	2.000	.065	1.35	995	796	69	55
●	●	●	●	●	2-1/2"	2.500	.065	1.70	793	635	55	44
●	●	●	●	●	3"	3.000	.065	2.05	659	528	45	36
●	●	●	●	●	4"	4.000	.083	3.49	631	505	44	35
●	●	●	●	●	6"	6.000	.109	6.90	551	440	38	30

* Gauge pressure is listed.

Notes:

1. Maximum safe working pressure is calculated per ASME B 31.3-2014, paragraph 304.1.2 (formula 3a). Calculations assume maximum allowable O.D. and minimum allowable wall thickness (worst case scenario).
2. Material: TP 304L or TP 316L per ASTM A269 and A632.
3. Temperature range used for above calculations is -20°F to 300°F, -28.8°C to 148.9°C. For recommended working pressures higher than 300°F, please consult factory.

Tube

Hastelloy® C-22®

Product Line	Dimensions in Inches							
222	Size	O.D.	Wall	Weight per foot (lbs.)	Maximum Safe Working Pressure*			
					PSI Seamless	PSI Welded	Bar Seamless	Bar Welded
●	1/4"	.250	.035	.08	4,969	N/A	343	N/A
●	3/8"	.375	.035	.13	3,222	N/A	222	N/A
●	1/2"	.500	.049	.24	3,407	N/A	235	N/A

* Gauge pressure is listed.

Notes:

1. Maximum safe working pressure is calculated per ASME B 31.3-2014, paragraph 304.1.2 (formula 3a). Calculations assume maximum allowable O.D. and minimum allowable wall thickness (worst case scenario).
2. Material: Hastelloy® C-22®, Hastelloy and C-22 are registered trademarks of Haynes International Inc.
3. Temperature range used for above calculations is -20°F to 300°F, -28.8°C to 148.9°C. For recommended working pressures higher than 300°F, please consult factory.

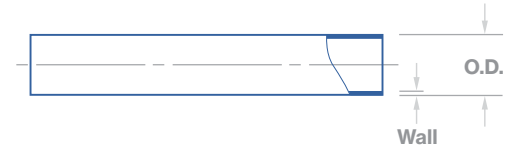

Pipe

ASTM A312, Schedule 10S

Product Lines		Dimensions in Inches								
LDEP	CFOS	Size	Sch.	O.D.	Wall	Weight per foot (lb.)	Maximum Safe Working Pressure*			
							PSI Seamless	PSI Welded	Bar Seamless	Bar Welded
●	●	NPS 2	10S	2.375	.109	2.66	1,367	1,094	94	75
●	●	NPS 2-1/2	10S	2.875	.120	3.56	1,243	994	86	69
●	●	NPS 3	10S	3.500	.120	4.36	1,017	814	70	56
●	●	NPS 3-1/2	10S	4.000	.120	5.01	888	711	61	49
●	●	NPS 4	10S	4.500	.120	5.66	789	631	54	44
●	●	NPS 5	10S	5.563	.134	7.83	708	566	49	39
●	●	NPS 6	10S	6.625	.134	9.36	594	475	41	33
●	●	NPS 8	10S	8.625	.148	13.50	504	403	35	28
●	●	NPS 10	10S	10.750	.165	18.79	449	360	31	25
●	●	NPS 12	10S	12.750	.180	24.34	414	331	29	23
	●	NPS 14	10S	14.000	.188	27.94	394	315	27	22
	●	NPS 16	10S	16.000	.188	31.98	344	275	24	19
	●	NPS 18	10S	18.000	.188	36.03	306	245	21	17
	●	NPS 20	10S	20.000	.218	46.40	N/A	255	N/A	18
	●	NPS 22	10S	22.000	.218	51.09	N/A	232	N/A	16
	●	NPS 24	10S	24.000	.250	63.88	N/A	244	N/A	17
	●	NPS 30	10S	30.000	.312	99.66	N/A	244	N/A	17

* Gauge pressure is listed.

Notes:

1. Maximum safe working pressure is calculated, per ASME B31.3-2014, paragraph 304.1.2. Calculations assume maximum allowable O.D. and minimum allowable wall thickness (worst case scenario).
2. Material: TP304, TP 304L or TP 316L per ASTM A312
3. Temperature range used for above calculations is -20°F to 300°F, -28.8°C to 148.9°C. For recommended working pressures higher than 300°F, please consult factory.

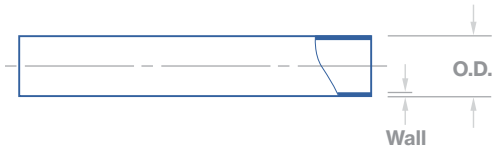

Pipe

JIS G3459 / G3468, Schedule 5S

Product Lines					Dimensions in Millimeters								
401	LDEP	201	101	CFOS	Size	Sch.	O.D.	Wall	Weight per meter (kg.)	Maximum Safe Working Pressure*			
										PSI Seamless	PSI Welded	Bar Seamless	Bar Welded
●					8A	5S	13.8	1.20	.38	2,511	2,009	173	139
●					10A	5S	17.3	1.20	.48	1,988	1,590	137	110
●		●	●		15A	5S	21.7	1.65	.82	2,324	1,859	160	128
●		●	●		20A	5S	27.2	1.65	1.05	1,839	1,471	127	101
●	●	●	●	●	25A	5S	34.0	1.65	1.32	1,460	1,168	101	81
●	●	●	●	●	32A	5S	42.7	1.65	1.68	1,154	923	80	64
●	●	●	●	●	40A	5S	48.6	1.65	1.92	1,011	808	70	56
●	●	●	●	●	50A	5S	60.5	1.65	2.41	808	646	56	45
●	●	●	●	●	65A	5S	76.3	2.10	3.87	836	668	58	46
●	●	●	●	●	80A	5S	89.1	2.10	4.53	713	571	49	39
●	●	●	●	●	90A	5S	101.6	2.10	5.19	624	499	43	34
●	●	●	●	●	100A	5S	114.3	2.10	5.85	554	443	38	31
●	●	●	●	●	125A	5S	139.8	2.80	9.52	605	484	42	33
●	●	●	●	●	150A	5S	165.2	2.80	11.29	511	408	35	28
●	●	●	●	●	200A	5S	216.3	2.80	14.84	389	311	27	21
●	●	●	●	●	250A	5S	267.4	3.40	22.28	382	306	26	21
●	●	●	●	●	300A	5S	318.5	4.00	31.22	377	302	26	21
	●	●	●	●	350A	5S	355.6	4.00	34.90	N/A	264	N/A	18
	●	●	●	●	400A	5S	406.4	4.50	44.89	N/A	260	N/A	18
	●	●	●	●	450A	5S	457.2	4.50	50.56	N/A	231	N/A	16
	●	●	●	●	500A	5S	508.0	5.00	62.42	N/A	231	N/A	16
	●	●	●	●	550A	5S	558.8	5.00	68.72	N/A	209	N/A	14
	●	●	●	●	600A	5S	609.6	5.50	82.46	N/A	211	N/A	15
				●	650A	5S	660.4	5.50	89.40	N/A	195	N/A	13
				●	700A	5S	711.2	5.50	96.33	N/A	181	N/A	12
				●	750A	5S	762.0	6.50	121.88	N/A	200	N/A	14

* Gauge pressure is listed.

Notes:

1. Maximum safe working pressure is calculated, per ASME B31.3-2014, paragraph 304.1.2. Calculations assume maximum allowable O.D. and minimum allowable wall thickness (worst case scenario).
2. Material: SUS 304LTP or SUS 316LTP per JIS G3459, and SUS 304 LTPY, SUS 316 LTPY per JIS G3468
3. Temperature range used for above calculations is -20°F to 300°F, -28.8°C to 148.9°C. For recommended working pressures higher than 300°F, please consult factory.

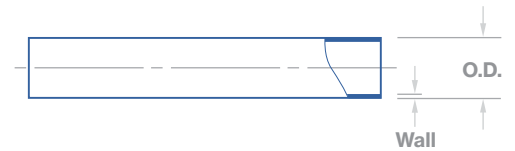

Pipe

JIS G3459 / G3468, Schedule 10S

Product Lines					Dimensions in Millimeters								
401	LDEP	201	101	CFOS	Size	Sch.	O.D.	Wall	Weight per meter (kg.)	Maximum Safe Working Pressure*			
										PSI Seamless	PSI Welded	Bar Seamless	Bar Welded
●					8A	10S	13.8	1.65	.50	3,743	2,994	258	206
●					10A	10S	17.3	1.65	.64	2,946	2,357	203	163
●		●	●		15A	10S	21.7	2.10	1.02	3,081	2,465	212	170
●		●	●		20A	10S	27.2	2.10	1.31	2,429	1,943	168	134
●	●	●	●	●	25A	10S	34.0	2.80	2.17	2,604	2,083	180	144
●	●	●	●	●	32A	10S	42.7	2.80	2.77	2,047	1,638	141	113
●	●	●	●	●	40A	10S	48.6	2.80	3.18	1,788	1,431	123	99
●	●	●	●	●	50A	10S	60.5	2.80	4.01	1,424	1,140	98	79
●	●	●	●	●	65A	10S	76.3	3.00	5.46	1,204	963	83	66
●	●	●	●	●	80A	10S	89.1	3.00	6.41	1,027	821	71	57
●	●	●	●	●	90A	10S	101.6	3.00	7.34	898	718	62	50
●	●	●	●	●	100A	10S	114.3	3.00	8.29	796	637	55	44
●	●	●	●	●	125A	10S	139.8	3.40	11.51	737	589	51	41
●	●	●	●	●	150A	10S	165.2	3.40	13.65	622	497	43	34
●	●	●	●	●	200A	10S	216.3	4.00	21.08	558	446	38	31
●	●	●	●	●	250A	10S	267.4	4.00	26.15	450	360	31	25
●	●	●	●	●	300A	10S	318.5	4.50	35.07	425	340	29	23
	●	●	●	●	350A	10S	355.6	5.00	43.51	N/A	330	N/A	23
	●	●	●	●	400A	10S	406.4	5.00	49.81	N/A	289	N/A	20
	●	●	●	●	450A	10S	457.2	5.00	56.11	N/A	256	N/A	18
	●	●	●	●	500A	10S	508.0	5.50	68.59	N/A	254	N/A	18
	●	●	●	●	550A	10S	558.8	5.50	75.53	N/A	231	N/A	16
	●	●	●	●	600A	10S	609.6	6.50	97.29	N/A	250	N/A	17
				●	650A	10S	660.4	8.00	129.53	N/A	292	N/A	20
				●	700A	10S	711.2	8.00	139.62	N/A	271	N/A	19
				●	750A	10S	762.0	8.00	149.71	N/A	253	N/A	17

* Gauge pressure is listed.

Notes:

1. Maximum safe working pressure is calculated, per ASME B31.3-2014, paragraph 304.1.2. Calculations assume maximum allowable O.D. and minimum allowable wall thickness (worst case scenario).
2. Material: SUS 304LTP or SUS 316LTP per JIS G3459, and SUS 304 LTPY, SUS 316 LTPY per JIS G3468
3. Temperature range used for above calculations is -20°F to 300°F, -28.8°C to 148.9°C. For recommended working pressures higher than 300°F, please consult factory.

Elbows

- 90° Elbows
- 45° Elbows



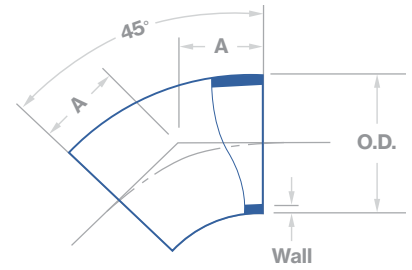

CONFIGURATION
2KLS

45° Elbow, Long

ASME B16.9 Standard, ASME Pipe

Product Lines		Dimensions in Inches				
LDEP	CFOS	Size	Sch.	O.D.	Wall	A
	●	NPS 1/2	10S	.84	.083	.62
	●	NPS 3/4	10S	1.05	.083	.75
	●	NPS 1	10S	1.32	.109	.88
	●	NPS 1-1/4	10S	1.66	.109	1.00
	●	NPS 1-1/2	10S	1.90	.109	1.12
●	●	NPS 2	10S	2.38	.109	1.38
●	●	NPS 2-1/2	10S	2.88	.120	1.75
●	●	NPS 3	10S	3.50	.120	2.00
●	●	NPS 3-1/2	10S	4.00	.120	2.25
●	●	NPS 4	10S	4.50	.120	2.50
●	●	NPS 5	10S	5.56	.134	3.12
●	●	NPS 6	10S	6.62	.134	3.75
●	●	NPS 8	10S	8.62	.148	5.00
●	●	NPS 10	10S	10.75	.165	6.25
●	●	NPS 12	10S	12.75	.180	7.50
	●	NPS 14	10S	14.00	.188	8.75
	●	NPS 16	10S	16.00	.188	10.00
	●	NPS 18	10S	18.00	.188	11.25
	●	NPS 20	10S	20.00	.218	12.50
	●	NPS 22	10S	22.00	.218	13.50
	●	NPS 24	10S	24.00	.250	15.00

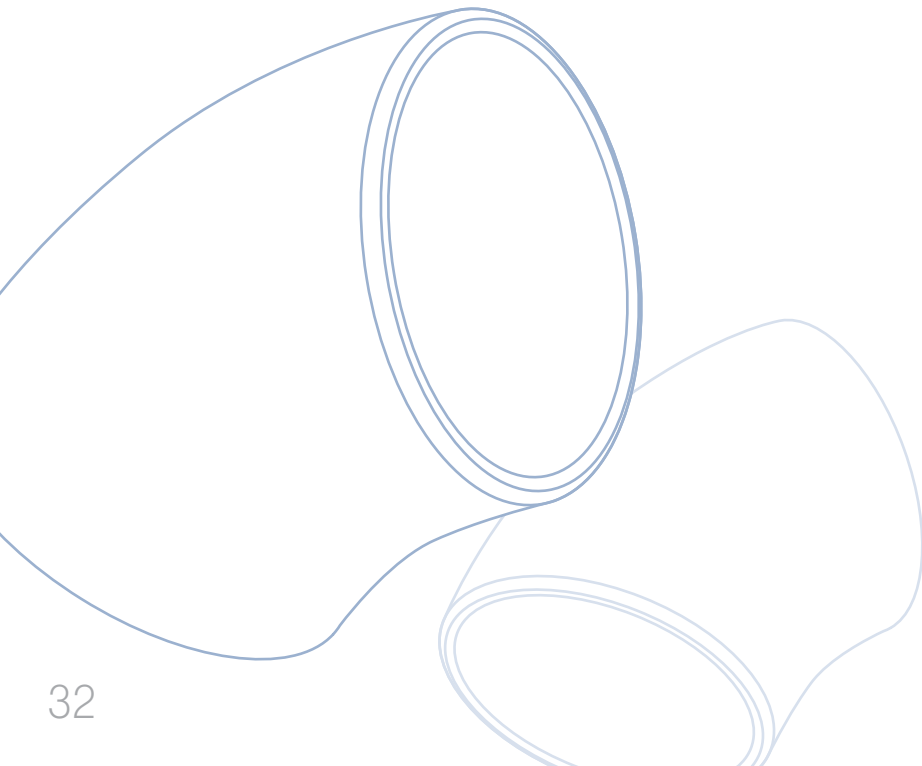

Tees

- Equal Tees
- Reducing Tees





Reducing Tee

ASME B16.9 Standard, ASME Pipe CONTINUED



Product Lines		Dimensions in Inches							
LDEP	CFOS	Size	Sch.	O.D. 1	Wall 1	O.D. 2	Wall 2	A	B
	●	NPS 4 x NPS 1-1/2	10S x 10S	4.50	.120	1.90	.109	4.12	3.38
●	●	NPS 4 x NPS 2	10S x 10S	4.50	.120	2.38	.109	4.12	3.50
●	●	NPS 4 x NPS 2-1/2	10S x 10S	4.50	.120	2.88	.120	4.12	3.75
●	●	NPS 4 x NPS 3	10S x 10S	4.50	.120	3.50	.120	4.12	3.88
●	●	NPS 4 x NPS 3-1/2	10S x 10S	4.50	.120	4.00	.120	4.12	4.00
●	●	NPS 5 x NPS 2	10S x 10S	5.56	.134	2.38	.109	4.88	4.12
●	●	NPS 5 x NPS 2-1/2	10S x 10S	5.56	.134	2.88	.120	4.88	4.25
●	●	NPS 5 x NPS 3	10S x 10S	5.56	.134	3.50	.120	4.88	4.38
●	●	NPS 5 x NPS 3-1/2	10S x 10S	5.56	.134	4.00	.120	4.88	4.50
●	●	NPS 5 x NPS 4	10S x 10S	5.56	.134	4.50	.120	4.88	4.62
●	●	NPS 6 x NPS 2-1/2	10S x 10S	6.62	.134	2.88	.120	5.62	4.75
●	●	NPS 6 x NPS 3	10S x 10S	6.62	.134	3.50	.120	5.62	4.88
●	●	NPS 6 x NPS 3-1/2	10S x 10S	6.62	.134	4.00	.120	5.62	5.00
●	●	NPS 6 x NPS 4	10S x 10S	6.62	.134	4.50	.120	5.62	5.12
●	●	NPS 6 x NPS 5	10S x 10S	6.62	.134	5.56	.134	5.62	5.38
●	●	NPS 8 x NPS 3-1/2	10S x 10S	8.62	.148	4.00	.120	7.00	6.00
●	●	NPS 8 x NPS 4	10S x 10S	8.62	.148	4.50	.120	7.00	6.12
●	●	NPS 8 x NPS 5	10S x 10S	8.62	.148	5.56	.134	7.00	6.38
●	●	NPS 8 x NPS 6	10S x 10S	8.62	.148	6.62	.134	7.00	6.62
●	●	NPS 10 x NPS 4	10S x 10S	10.75	.165	4.50	.120	8.50	7.25
●	●	NPS 10 x NPS 5	10S x 10S	10.75	.165	5.56	.134	8.50	7.50
●	●	NPS 10 x NPS 6	10S x 10S	10.75	.165	6.62	.134	8.50	7.62
●	●	NPS 10 x NPS 8	10S x 10S	10.75	.165	8.62	.148	8.50	8.00
●	●	NPS 12 x NPS 5	10S x 10S	12.75	.180	5.56	.134	10.00	8.50
●	●	NPS 12 x NPS 6	10S x 10S	12.75	.180	6.62	.134	10.00	8.62
●	●	NPS 12 x NPS 8	10S x 10S	12.75	.180	8.62	.148	10.00	9.00
●	●	NPS 12 x NPS 10	10S x 10S	12.75	.180	10.75	.165	10.00	9.50
	●	NPS 14 x NPS 6	10S x 10S	14.00	.188	6.62	.134	11.00	9.38
	●	NPS 14 x NPS 8	10S x 10S	14.00	.188	8.62	.148	11.00	9.75
	●	NPS 14 x NPS 10	10S x 10S	14.00	.188	10.75	.165	11.00	10.12
	●	NPS 14 x NPS 12	10S x 10S	14.00	.188	12.75	.180	11.00	10.62
	●	NPS 16 x NPS 6	10S x 10S	16.00	.188	6.62	.134	12.00	10.38
	●	NPS 16 x NPS 8	10S x 10S	16.00	.188	8.62	.148	12.00	10.75
	●	NPS 16 x NPS 10	10S x 10S	16.00	.188	10.75	.165	12.00	11.12
	●	NPS 16 x NPS 12	10S x 10S	16.00	.188	12.75	.180	12.00	11.62
	●	NPS 16 x NPS 14	10S x 10S	16.00	.188	14.00	.188	12.00	12.00
	●	NPS 18 x NPS 8	10S x 10S	18.00	.188	8.62	.148	13.50	11.75
	●	NPS 18 x NPS 10	10S x 10S	18.00	.188	10.75	.165	13.50	12.12
	●	NPS 18 x NPS 12	10S x 10S	18.00	.188	12.75	.180	13.50	12.62
	●	NPS 18 x NPS 14	10S x 10S	18.00	.188	14.00	.188	13.50	13.00
	●	NPS 18 x NPS 16	10S x 10S	18.00	.188	16.00	.188	13.50	13.00
	●	NPS 20 x NPS 8	10S x 10S	20.00	.218	8.62	.148	15.00	12.75
	●	NPS 20 x NPS 10	10S x 10S	20.00	.218	10.75	.165	15.00	13.12
	●	NPS 20 x NPS 12	10S x 10S	20.00	.218	12.75	.180	15.00	13.62
	●	NPS 20 x NPS 14	10S x 10S	20.00	.218	14.00	.188	15.00	14.00
	●	NPS 20 x NPS 16	10S x 10S	20.00	.218	16.00	.188	15.00	14.00
	●	NPS 20 x NPS 18	10S x 10S	20.00	.218	18.00	.188	15.00	14.50



Reducing Tee

ASME B16.9 Standard, ASME Pipe CONTINUED

Product Lines		Dimensions in Inches							
LDEP	CFOS	Size	Sch.	O.D. 1	Wall 1	O.D. 2	Wall 2	A	B
	●	NPS 22 x NPS 10	10S x 10S	22.00	.218	10.75	.165	16.50	14.12
	●	NPS 22 x NPS 12	10S x 10S	22.00	.218	12.75	.180	16.50	14.62
	●	NPS 22 x NPS 14	10S x 10S	22.00	.218	14.00	.188	16.50	15.00
	●	NPS 22 x NPS 16	10S x 10S	22.00	.218	16.00	.188	16.50	15.00
	●	NPS 22 x NPS 18	10S x 10S	22.00	.218	18.00	.188	16.50	15.50
	●	NPS 22 x NPS 20	10S x 10S	22.00	.218	20.00	.218	16.50	16.00
	●	NPS 24 x NPS 10	10S x 10S	24.00	.250	10.75	.165	17.00	15.12
	●	NPS 24 x NPS 12	10S x 10S	24.00	.250	12.75	.180	17.00	15.62
	●	NPS 24 x NPS 14	10S x 10S	24.00	.250	14.00	.188	17.00	16.00
	●	NPS 24 x NPS 16	10S x 10S	24.00	.250	16.00	.188	17.00	16.00
	●	NPS24 x NPS 18	10S x 10S	24.00	.250	18.00	.188	17.00	16.50
	●	NPS 24 x NPS 20	10S x 10S	24.00	.250	20.00	.218	17.00	17.00
	●	NPS 24 x NPS 22	10S x 10S	24.00	.250	22.00	.218	17.00	17.00

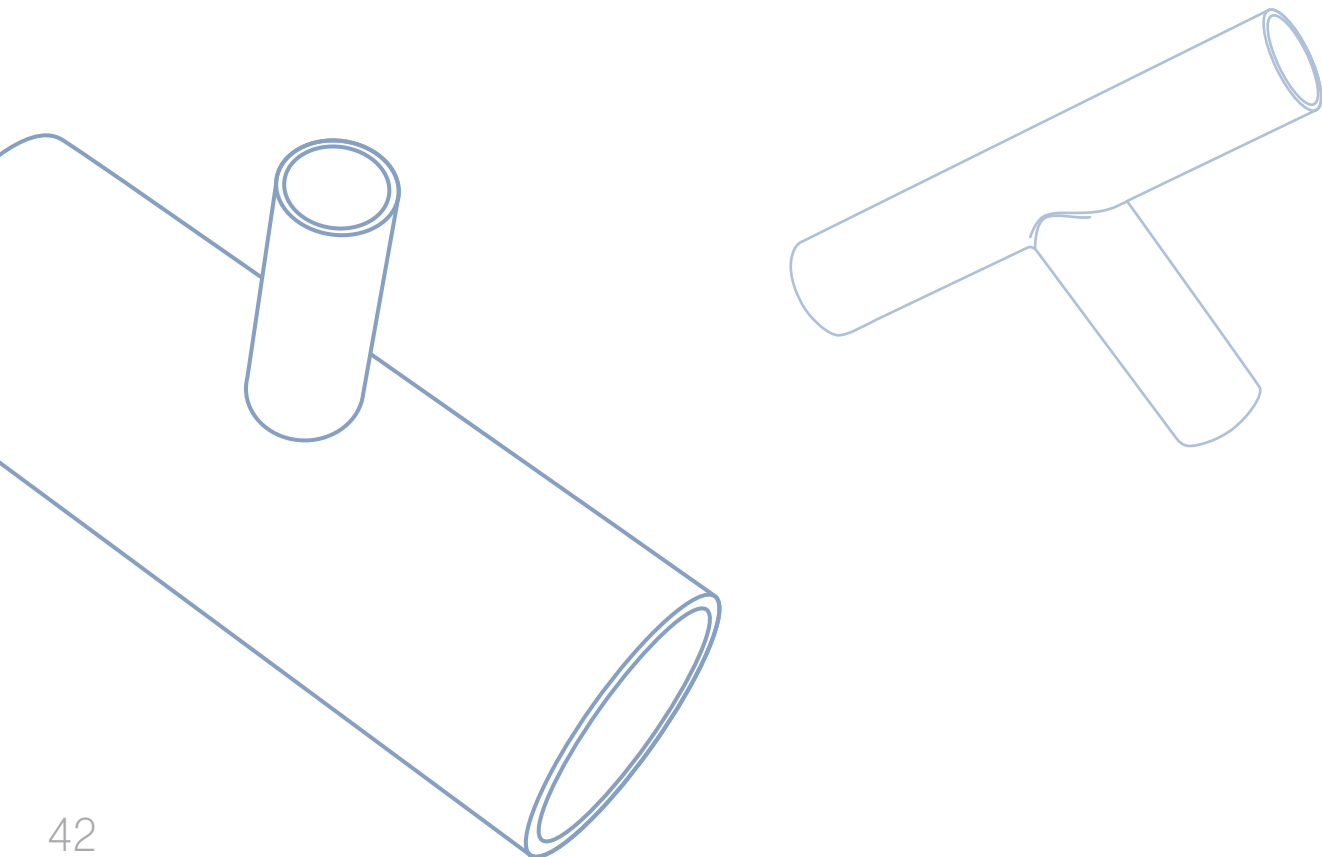

Crosses

- Equal Crosses



Reducers

- Concentric Reducers
- Cap Reducers



CONFIGURATION
31

Concentric Reducer

ASME B16.9 Standard, ASME Pipe CONTINUED

Product Lines		Dimensions in Inches						
LDEP	CFOS	Size	Sch.	O.D. 1	Wall 1	O.D. 2	Wall 2	A
●	●	NPS 8 x NPS 3-1/2	10S x 10S	8.62	.148	4.00	.120	6.00
●	●	NPS 8 x NPS 4	10S x 10S	8.62	.148	4.50	.120	6.00
●	●	NPS 8 x NPS 5	10S x 10S	8.62	.148	5.56	.134	6.00
●	●	NPS 8 x NPS 6	10S x 10S	8.62	.148	6.62	.134	6.00
●	●	NPS 10 x NPS 4	10S x 10S	10.75	.165	4.50	.120	7.00
●	●	NPS 10 x NPS 5	10S x 10S	10.75	.165	5.56	.134	7.00
●	●	NPS 10 x NPS 6	10S x 10S	10.75	.165	6.62	.134	7.00
●	●	NPS 10 x NPS 8	10S x 10S	10.75	.165	8.62	.148	7.00
●	●	NPS 12 x NPS 5	10S x 10S	12.75	.180	5.56	.134	8.00
●	●	NPS 12 x NPS 6	10S x 10S	12.75	.180	6.62	.134	8.00
●	●	NPS 12 x NPS 8	10S x 10S	12.75	.180	8.62	.148	8.00
●	●	NPS 12 x NPS 10	10S x 10S	12.75	.180	10.75	.165	8.00
	●	NPS 14 x NPS 6	10S x 10S	14.00	.188	6.62	.134	13.00
	●	NPS 14 x NPS 8	10S x 10S	14.00	.188	8.62	.148	13.00
	●	NPS 14 x NPS 10	10S x 10S	14.00	.188	10.75	.165	13.00
	●	NPS 14 x NPS 12	10S x 10S	14.00	.188	12.75	.180	13.00
	●	NPS 16 x NPS 8	10S x 10S	16.00	.188	8.62	.148	14.00
	●	NPS 16 x NPS 10	10S x 10S	16.00	.188	10.75	.165	14.00
	●	NPS 16 x NPS 12	10S x 10S	16.00	.188	12.75	.180	14.00
	●	NPS 16 x NPS 14	10S x 10S	16.00	.188	14.00	.188	14.00
	●	NPS 18 x NPS 10	10S x 10S	18.00	.188	10.75	.165	15.00
	●	NPS 18 x NPS 12	10S x 10S	18.00	.188	12.75	.180	15.00
	●	NPS 18 x NPS 14	10S x 10S	18.00	.188	14.00	.188	15.00
	●	NPS 18 x NPS 16	10S x 10S	18.00	.188	16.00	.188	15.00
	●	NPS 20 x NPS 12	10S x 10S	20.00	.218	12.75	.180	20.00
	●	NPS 20 x NPS 14	10S x 10S	20.00	.218	14.00	.188	20.00
	●	NPS 20 x NPS 16	10S x 10S	20.00	.218	16.00	.188	20.00
	●	NPS 20 x NPS 18	10S x 10S	20.00	.218	18.00	.188	20.00
	●	NPS 22 x NPS 14	10S x 10S	22.00	.218	14.00	.188	20.00
	●	NPS 22 x NPS 16	10S x 10S	22.00	.218	16.00	.188	20.00
	●	NPS 22 x NPS 18	10S x 10S	22.00	.218	18.00	.188	20.00
	●	NPS 22 x NPS 20	10S x 10S	22.00	.218	20.00	.218	20.00
	●	NPS 24 x NPS 16	10S x 10S	24.00	.250	16.00	.188	20.00
	●	NPS 24 x NPS 18	10S x 10S	24.00	.250	18.00	.188	20.00
	●	NPS 24 x NPS 20	10S x 10S	24.00	.250	20.00	.218	20.00
	●	NPS 24 x NPS 22	10S x 10S	24.00	.250	22.00	.218	20.00

End Caps



Stub Ends

- Tube Stub Ends
- Lap Joint Stub Ends



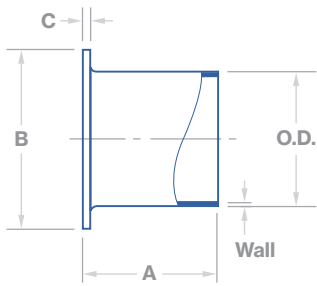

Tube Stub End, Long

Valex Standard, ASTM Tube

CONFIGURATION
38LE
Use With
38PF

Product Lines	
401	201
●	●
●	●
●	●
●	●
●	●
●	●
●	●
●	●
●	●

Dimensions in Inches					
Size	O.D.	Wall	A	B	C
1/2"	.500	.049	2.875	1.625	.098
3/4"	.750	.065	2.875	1.688	.098
1"	1.000	.065	3.125	2.000	.130
1-1/2"	1.500	.065	3.250	2.875	.130
2"	2.000	.065	3.000	3.625	.130
2-1/2"	2.500	.065	4.000	4.125	.130
3"	3.000	.065	4.250	5.000	.166
4"	4.000	.083	5.625	6.188	.166
6"	6.000	.109	7.000	8.500	.218

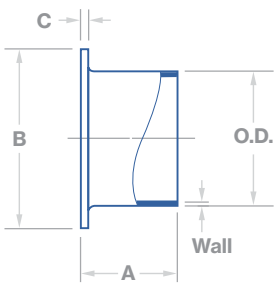

Tube Stub End, Short

Valex Standard, ASTM Tube

CONFIGURATION
38SE
Use With
38PF

Product Lines	
401	201
●	●
●	●
●	●
●	●
●	●
●	●
●	●
●	●
●	●

Dimensions in Inches					
Size	O.D.	Wall	A	B	C
1/2"	.500	.065	1.375	1.625	.098
3/4"	.750	.065	1.375	1.688	.098
1"	1.000	.065	1.625	2.000	.130
1-1/2"	1.500	.065	1.750	2.875	.130
2"	2.000	.065	1.500	3.625	.130
2-1/2"	2.500	.065	2.000	4.125	.130
3"	3.000	.065	2.250	5.000	.166
4"	4.000	.083	2.625	6.188	.166
6"	6.000	.109	3.000	8.500	.218

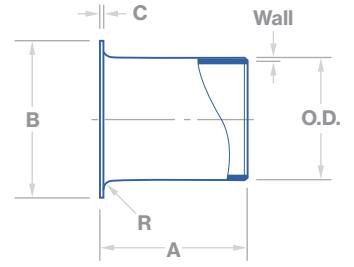

Lap Joint Stub End, Long

ASME B16.9 Standard, ASME Pipe

Product Lines		Dimensions in Inches							
LDEP	CFOS	Size	Sch.	O.D.	Wall	A	R	B	C
	•	NPS 1/2	10S	.809 - .896	.083	3.00	.12	1.38	.083
	•	NPS 3/4	10S	1.019 - 1.106	.083	3.00	.12	1.69	.083
	•	NPS 1	10S	1.284 - 1.376	.109	4.00	.12	2.00	.109
	•	NPS 1-1/4	10S	1.629 - 1.716	.109	4.00	.19	2.50	.109
	•	NPS 1-1/2	10S	1.869 - 1.965	.109	4.00	.25	2.88	.109
•	•	NPS 2	10S	2.344 - 2.456	.109	6.00	.31	3.62	.109
•	•	NPS 2-1/2	10S	2.844 - 2.966	.120	6.00	.31	4.12	.120
•	•	NPS 3	10S	3.469 - 3.596	.120	6.00	.38	5.00	.120
•	•	NPS 3-1/2	10S	3.969 - 4.096	.120	6.00	.38	5.50	.120
•	•	NPS 4	10S	4.469 - 4.593	.120	6.00	.44	6.19	.120
•	•	NPS 5	10S	5.532 - 5.683	.134	8.00	.44	7.31	.134
•	•	NPS 6	10S	6.594 - 6.743	.134	8.00	.50	8.50	.134
•	•	NPS 8	10S	8.594 - 8.743	.148	8.00	.50	10.62	.148
•	•	NPS 10	10S	10.719 - 10.913	.165	10.00	.50	12.75	.165
•	•	NPS 12	10S	12.719 - 12.913	.180	10.00	.50	15.00	.180
	•	NPS 14	10S	13.969 - 14.170	.188	12.00	.50	16.25	.188
	•	NPS 16	10S	15.969 - 16.180	.188	12.00	.50	18.50	.188
	•	NPS 18	10S	17.969 - 18.190	.188	12.00	.50	21.00	.188
	•	NPS 20	10S	19.969 - 20.240	.218	12.00	.50	23.00	.218
	•	NPS 24	10S	23.969 - 24.240	.250	12.00	.50	27.25	.250

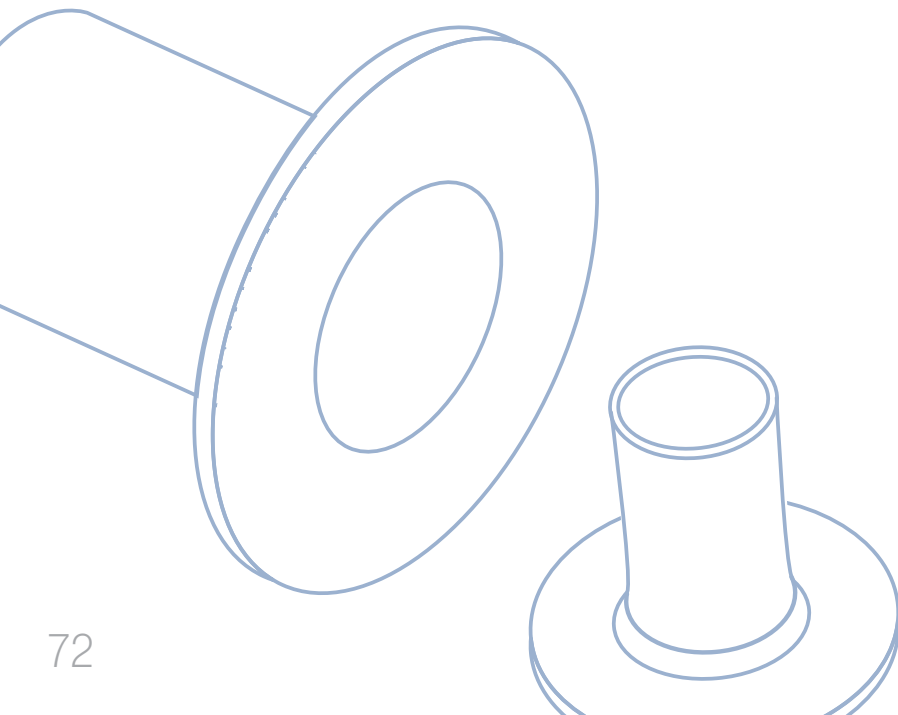

Dimensions



Lap Joint Stub End

Valex Standard, Nominal Pressure 5K

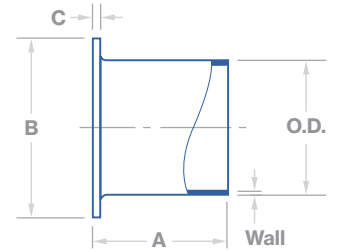

Product Lines				
401	LDEP	201	101	CFOS
●		●	●	●
●		●	●	●
●	●	●	●	●
●	●	●	●	●
●	●	●	●	●
●	●	●	●	●
●	●	●	●	●
●	●	●	●	●
●	●	●	●	●
●	●	●	●	●
●	●	●	●	●
●	●	●	●	●
●	●	●	●	●
●	●	●	●	●
●	●	●	●	●

Dimensions in Millimeters							
Size	O.D.	5S Wall	10S Wall	A*	R	B	C
15A	21.7	1.65	2.10	55	3.0	44	2.5
20A	27.2	1.65	2.10	55	3.0	49	2.5
25A	34.0	1.65	2.80	55	3.0	59	2.5
32A	42.7	1.65	2.80	70	3.0	70	2.5
40A	48.6	1.65	2.80	70	3.0	75	2.5
50A	60.5	1.65	2.80	70	4.0	85	2.5
65A	76.3	2.10	3.00	75	4.0	110	2.5
80A	89.1	2.10	3.00	75	5.0	121	2.5
100A	114.3	2.10	3.00	75	5.0	141	2.5
125A	139.8	2.80	3.40	50	5.0	182	5.0
150A	165.2	2.80	3.40	50	5.0	212	5.0
200A	216.3	2.80	4.00	65	5.0	262	7.0
250A	267.4	3.40	4.00	65	5.0	324	7.0
300A	318.5	4.00	4.50	65	5.0	368	9.0

* Sizes JIS 100A and smaller are suitable for automatic welding. Sizes JIS 125A and larger are suitable for manual welding.



Lap Joint Stub End

Valex Standard, Nominal Pressure 10K

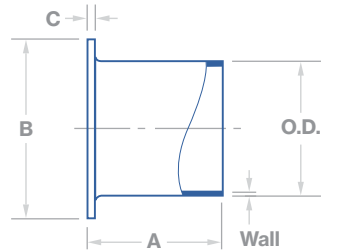

Product Lines				
401	LDEP	201	101	CFOS
●		●	●	●
●		●	●	●
●	●	●	●	●
●	●	●	●	●
●	●	●	●	●
●	●	●	●	●
●	●	●	●	●
●	●	●	●	●
●	●	●	●	●
●	●	●	●	●
●	●	●	●	●
●	●	●	●	●
●	●	●	●	●
●	●	●	●	●
●	●	●	●	●
●	●	●	●	●

Dimensions in Millimeters							
Size	O.D.	5S Wall	10S Wall	A*	R	B	C
15A	21.7	1.65	2.10	55	3.0	51	2.5
20A	27.2	1.65	2.10	55	3.0	56	2.5
25A	34.0	1.65	2.80	55	3.0	67	2.5
32A	42.7	1.65	2.80	70	3.0	76	2.5
40A	48.6	1.65	2.80	70	3.0	81	2.5
50A	60.5	1.65	2.80	70	4.0	96	2.5
65A	76.3	2.10	3.00	75	4.0	116	2.5
80A	89.1	2.10	3.00	75	5.0	126	2.5
100A	114.3	2.10	3.00	75	5.0	151	2.5
125A	139.8	2.80	3.40	50	5.0	182	5.0
150A	165.2	2.80	3.40	50	5.0	212	5.0
200A	216.3	2.80	4.00	65	5.0	262	7.0
250A	267.4	3.40	4.00	65	5.0	324	7.0
300A	318.5	4.00	4.50	65	5.0	368	9.0

* Sizes JIS 100A and smaller are suitable for automatic welding. Sizes JIS 125A and larger are suitable for manual welding.

Flanges

- Weld Neck Flanges
- Blind Flanges
- Blank Flanges
- Lap Joint Flanges
- Tube Plate Flanges



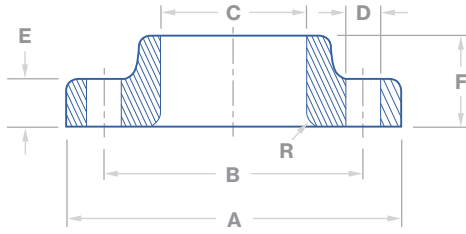

Lap Joint Flange

ASME B16.5 Standard, Class 150



Compatible with Product Lines*		Dimensions in Inches								
LDEP	CFOS	Size	A	B	C	D	E	F	R	# of Bolts
	●	NPS 1/2	3.50	2.38	.90	.625	.38	.62	.12	4
	●	NPS 3/4	3.88	2.75	1.11	.625	.44	.62	.12	4
	●	NPS 1	4.25	3.12	1.38	.625	.50	.69	.12	4
	●	NPS 1-1/4	4.62	3.50	1.72	.625	.56	.81	.19	4
	●	NPS 1-1/2	5.00	3.88	1.97	.625	.62	.88	.25	4
●	●	NPS 2	6.00	4.75	2.46	.750	.69	1.00	.31	4
●	●	NPS 2-1/2	7.00	5.50	2.97	.750	.81	1.12	.31	4
●	●	NPS 3	7.50	6.00	3.60	.750	.88	1.19	.38	4
●	●	NPS 3-1/2	8.50	7.00	4.10	.750	.88	1.25	.38	8
●	●	NPS 4	9.00	7.50	4.60	.750	.88	1.31	.44	8
●	●	NPS 5	10.00	8.50	5.69	.875	.88	1.44	.44	8
●	●	NPS 6	11.00	9.50	6.75	.875	.94	1.56	.50	8
●	●	NPS 8	13.50	11.75	8.75	.875	1.06	1.75	.50	8
●	●	NPS 10	16.00	14.25	10.92	1.000	1.12	1.94	.50	12
●	●	NPS 12	19.00	17.00	12.92	1.000	1.19	2.19	.50	12
	●	NPS 14	21.00	18.75	14.18	1.125	1.31	3.12	.50	12
	●	NPS 16	23.50	21.25	16.19	1.125	1.38	3.44	.50	16
	●	NPS 18	25.00	22.75	18.20	1.250	1.50	3.81	.50	16
	●	NPS 20	27.50	25.00	20.25	1.250	1.62	4.06	.50	20
	●	NPS 24	32.00	29.50	24.25	1.375	1.81	4.38	.50	20

* Lap joint flanges are only available in CFOS, but are compatible with the product lines listed above.

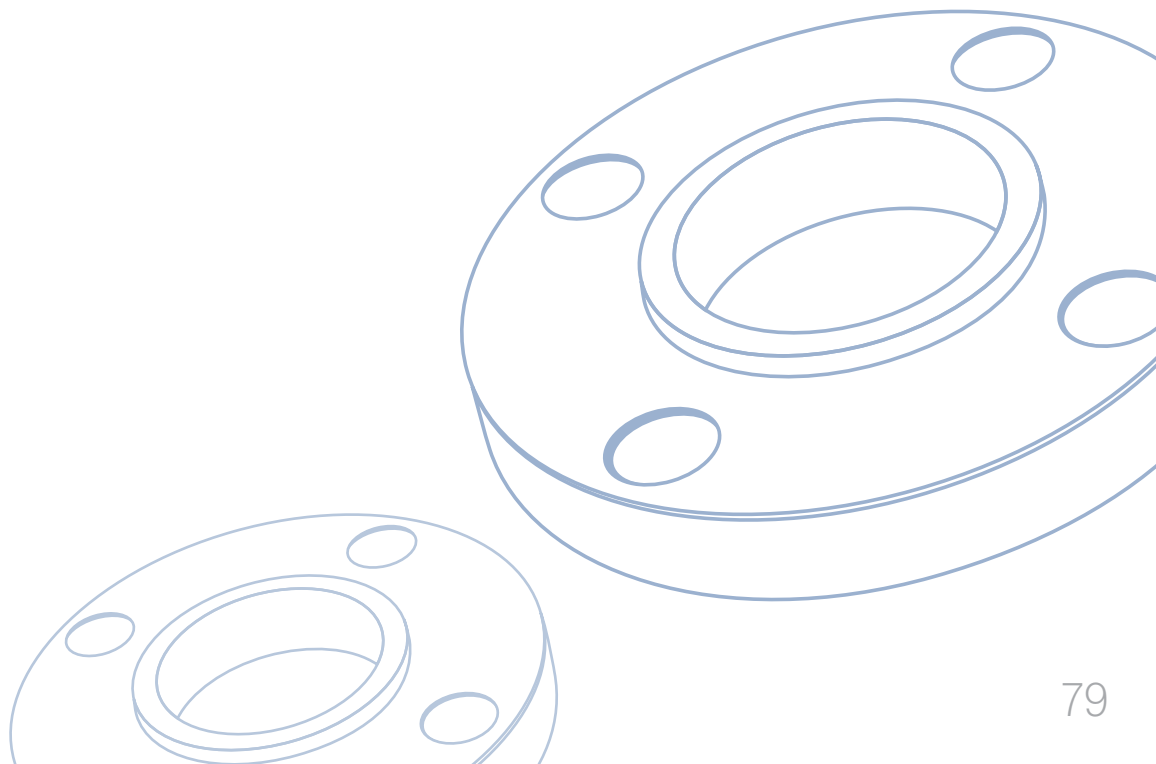

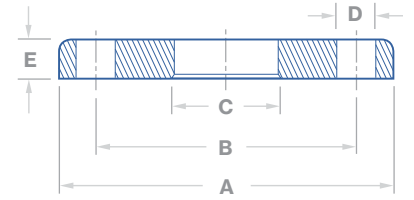

Lap Joint Flange

JIS B2220 Standard, Nominal Pressure 5K

Compatible with Product Lines*					Dimensions in Millimeters						
401	LDEP	201	101	CFOS	Size	A	B	C	D	E	# of Bolts
●		●	●	●	15A	80	60	23.4	12	9	4
●		●	●	●	20A	85	65	28.9	12	10	4
●	●	●	●	●	25A	95	75	35.6	12	10	4
●	●	●	●	●	32A	115	90	44.3	15	12	4
●	●	●	●	●	40A	120	95	50.4	15	12	4
●	●	●	●	●	50A	130	105	62.7	15	14	4
●	●	●	●	●	65A	155	130	78.7	15	14	4
●	●	●	●	●	80A	180	145	91.6	19	14	4
●	●	●	●	●	100A	200	165	116.9	19	16	8
●	●	●	●	●	125A	235	200	143.0	19	16	8
●	●	●	●	●	150A	265	230	168.4	19	18	8
●	●	●	●	●	200A	320	280	219.5	23	20	8
●	●	●	●	●	250A	385	345	271.7	23	22	12
●	●	●	●	●	300A	430	390	322.8	23	22	12

* Lap joint flanges are only available in CFOS, but are compatible with the product lines listed above.

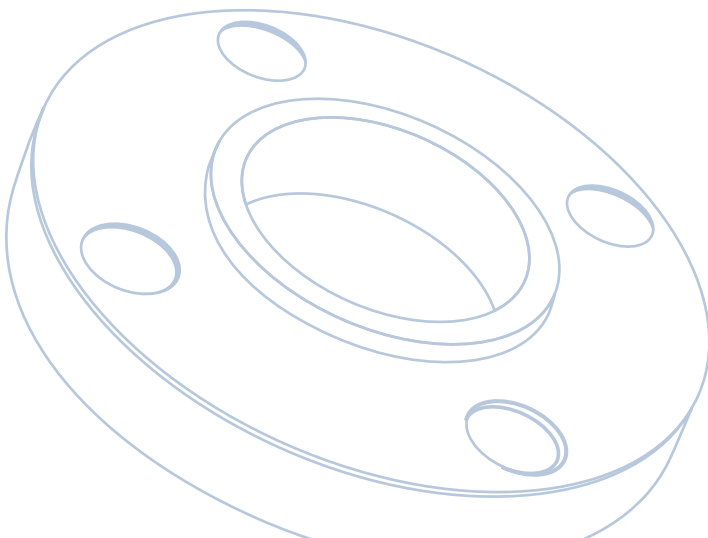



Dimensions

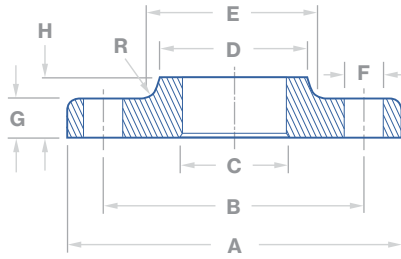
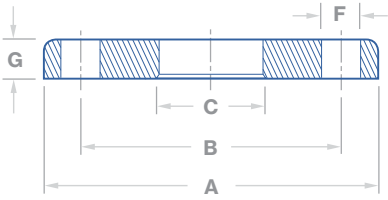

Lap Joint Flange

JIS B2220 Standard, Nominal Pressure 10K



Compatible with Product Lines*				
401	LDEP	201	101	CFOS
●		●	●	●
●		●	●	●
●	●	●	●	●
●	●	●	●	●
●	●	●	●	●
●	●	●	●	●
●	●	●	●	●
●	●	●	●	●
●	●	●	●	●
●	●	●	●	●
●	●	●	●	●
●	●	●	●	●
●	●	●	●	●
●	●	●	●	●
●	●	●	●	●
●	●	●	●	●

Dimensions in Millimeters														
Size	A	B	C	D	E	F	G	H	R	# of Bolts				
15A	95	70	23.4	N/A	N/A	15	12	N/A	N/A	4				
20A	100	75	28.9			4								
25A	125	90	35.6			19	14			4				
32A	135	100	44.3			19	16			4				
40A	140	105	50.4			19	16			4				
50A	155	120	62.7			19	16			4				
65A	175	140	78.7			19	18			4				
80A	185	150	91.6			19	18			8				
100A	210	175	116.9			19	18			8				
125A	250	210	143.0			23	20			8				
150A	280	240	168.4			23	22			8				
200A	330	290	219.5			23	22			12				
250A	400	355	271.7			288	292			25	24	36	6	12
300A	445	400	322.8			340	346			25	24	38	6	16

* Lap joint flanges are only available in CFOS, but are compatible with the product lines listed above.

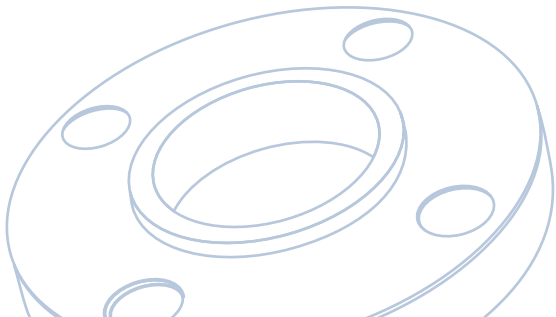
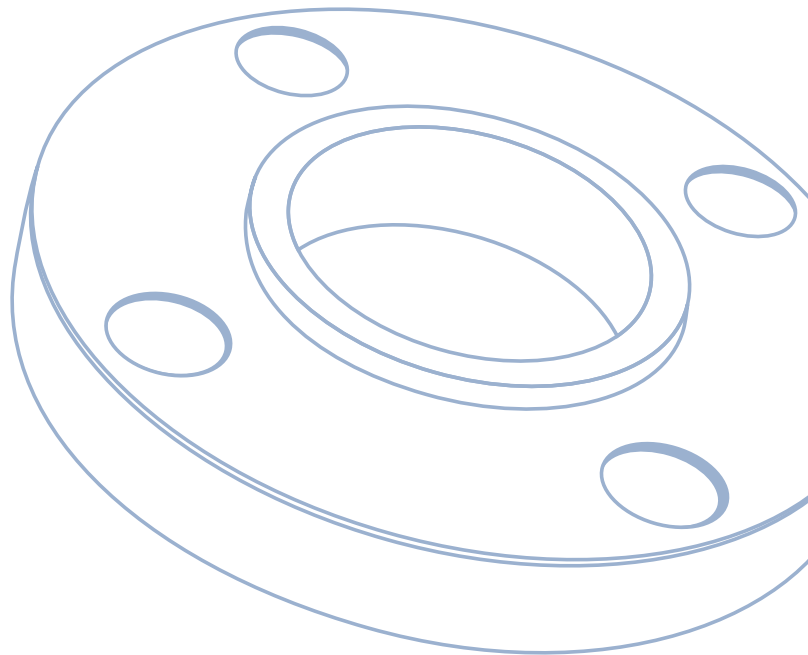

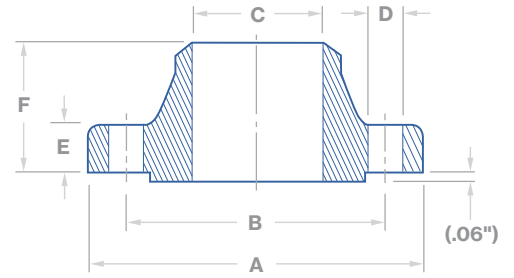

Weld Neck Flange

ASME B16.5 Standard, Class 150

Product Lines		Dimensions in Inches							
LDEP	CFOS	Size	A	B	C	D	E	F	# of Bolts
	•	NPS 1/2	3.50	2.38	.62	.625	.38	1.81	4
	•	NPS 3/4	3.88	2.75	.82	.625	.44	2.00	4
	•	NPS 1	4.25	3.12	1.05	.625	.50	2.12	4
	•	NPS 1-1/4	4.62	3.50	1.38	.625	.56	2.19	4
	•	NPS 1-1/2	5.00	3.88	1.61	.625	.62	2.38	4
•	•	NPS 2	6.00	4.75	2.07	.750	.69	2.44	4
•	•	NPS 2-1/2	7.00	5.50	2.47	.750	.81	2.69	4
•	•	NPS 3	7.50	6.00	3.07	.750	.88	2.69	4
•	•	NPS 3-1/2	8.50	7.00	3.55	.750	.88	2.75	8
•	•	NPS 4	9.00	7.50	4.03	.750	.88	2.94	8
•	•	NPS 5	10.00	8.50	5.05	.875	.88	3.44	8
•	•	NPS 6	11.00	9.50	6.07	.875	.94	3.44	8
•	•	NPS 8	13.50	11.75	7.98	.875	1.06	3.94	8
•	•	NPS 10	16.00	14.25	10.02	1.000	1.12	3.94	12
•	•	NPS 12	19.00	17.00	12.00	1.000	1.19	4.44	12
	•	NPS 14	21.00	18.75	Customer Specified	1.125	1.31	4.94	12
	•	NPS 16	23.50	21.25		1.125	1.38	4.94	16
	•	NPS 18	25.00	22.75		1.250	1.50	5.44	16
	•	NPS 20	27.50	25.00		1.250	1.62	5.62	20
	•	NPS 24	32.00	29.50		1.375	1.81	5.94	20

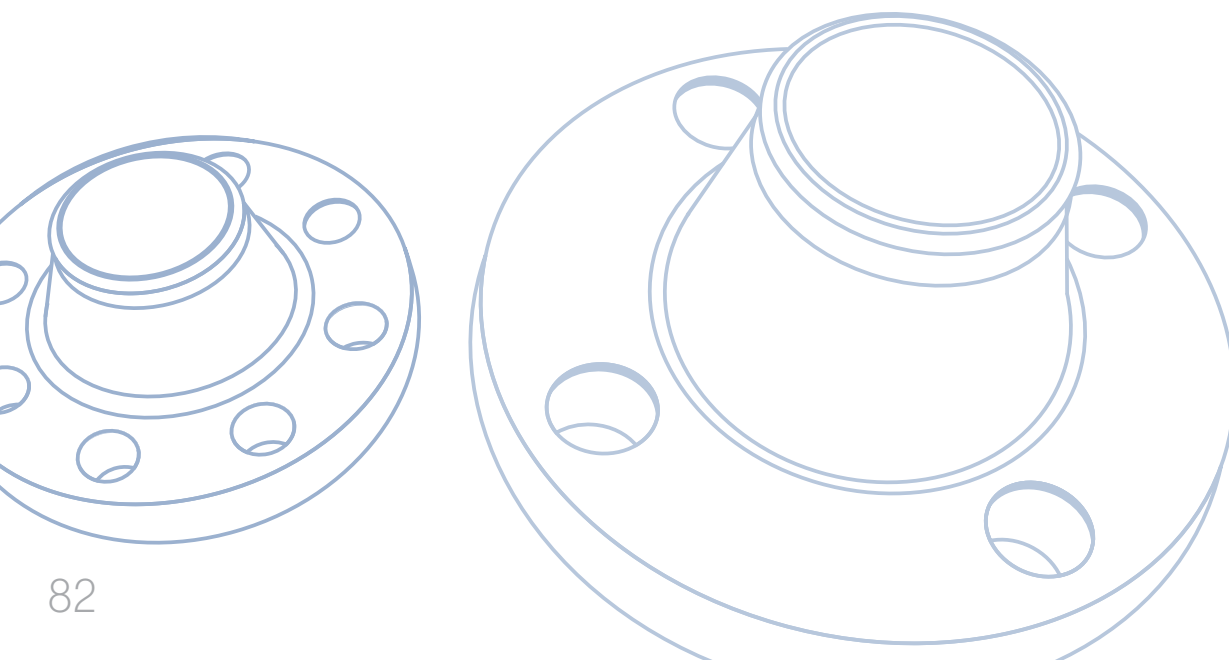

Coaxial Tube & Fittings

Coaxial Tube System

Valex pioneered the stainless steel Coaxial Tube System more than 30 years ago to meet the requirements set forth in codes and ordinances written at the inception of the semiconductor industry. Since then, we've gone on to design and deliver a full range of tube and fittings that “double-contain” toxic and hazardous gases for particularly dangerous processes. To provide absolute safety, all coaxial products are designed for automatic orbital welding in joint connections.

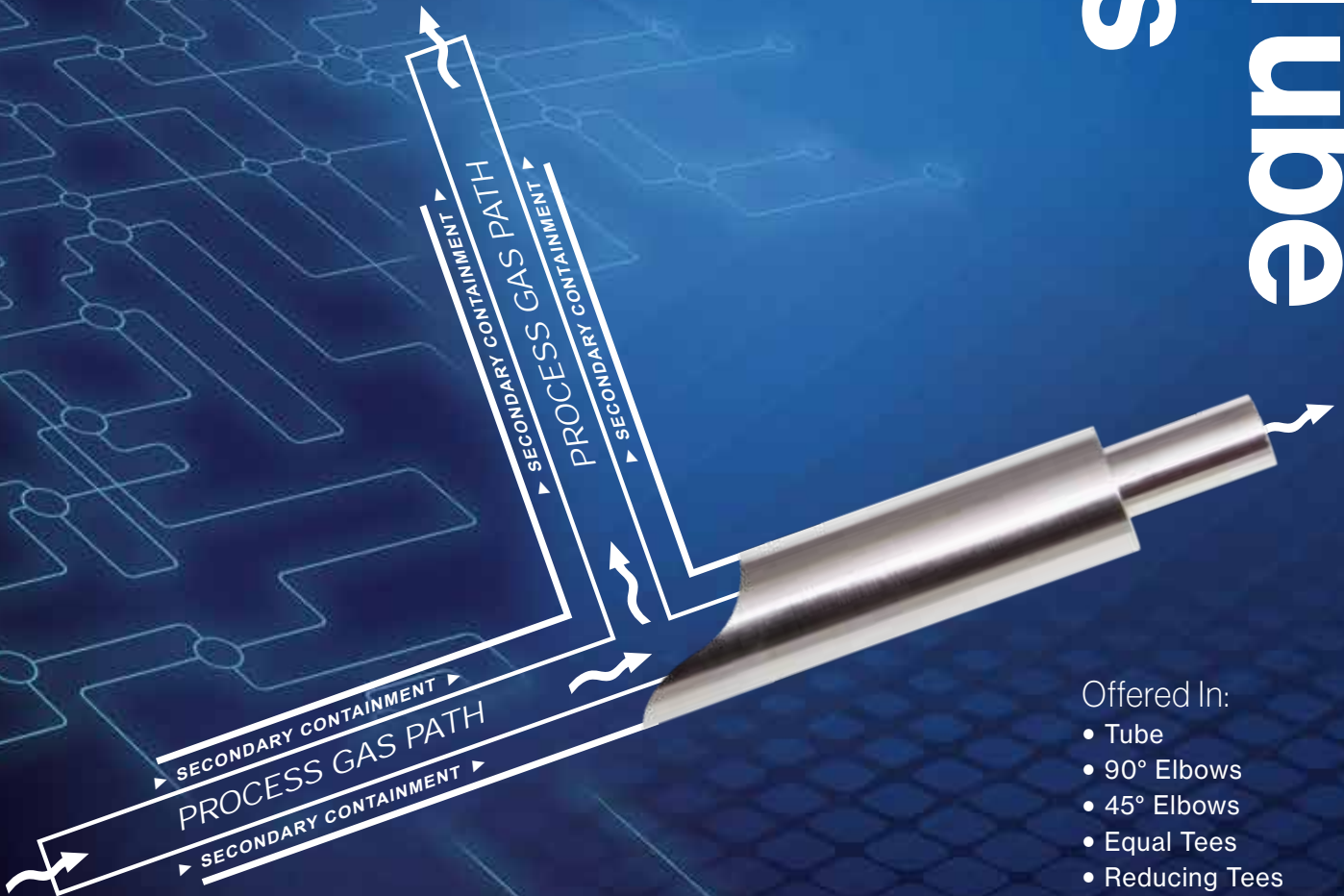

Offered In:

- Tube
- 90° Elbows
- 45° Elbows
- Equal Tees
- Reducing Tees
- Concentric Reducers
- Purge Tees
- Sleeves
- Weld Glands
- Terminators
- Bulkhead Fittings

Sleeve Assembly:

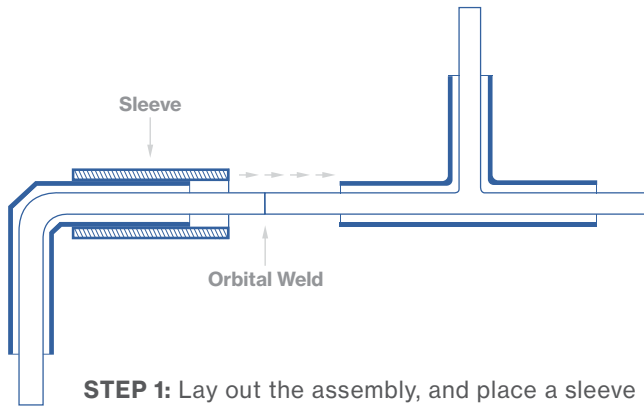

STEP 1: Lay out the assembly, and place a sleeve over one of the fittings. Weld the inner tube together, helium-leak test, and inspect the weld.

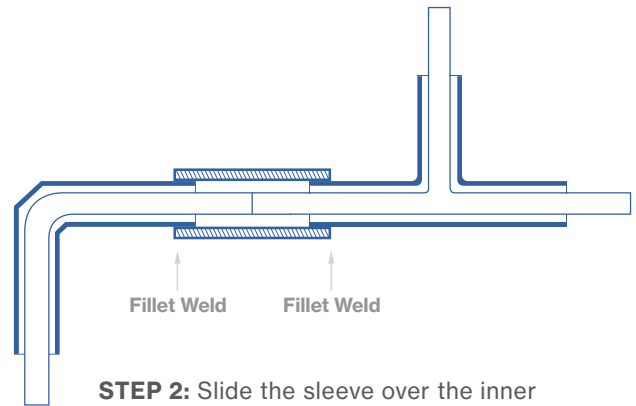

STEP 2: Slide the sleeve over the inner tube, so that it completely covers the gap between both outer jackets. Weld both ends, helium-leak test, and inspect.

Terminator Assembly:

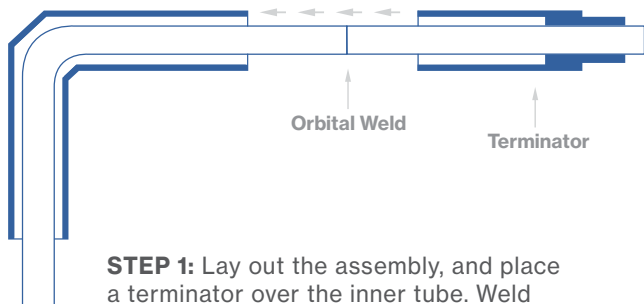

STEP 1: Lay out the assembly, and place a terminator over the inner tube. Weld the inner tubes together, helium-leak test, and inspect.

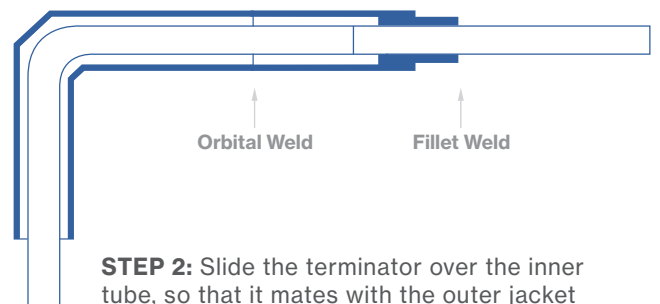

STEP 2: Slide the terminator over the inner tube, so that it mates with the outer jacket of the fitting. Weld both ends, helium-leak test, and inspect.

Tube to Tube Assembly:

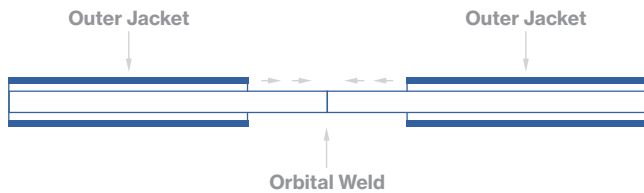

STEP 1: Lay out the assembly. Weld the inner tubes together, helium-leak test, and inspect.

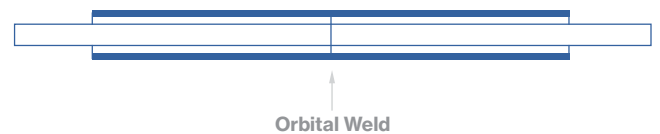

STEP 2: Slide the outer jackets together, so they completely enclose the inner tube. Weld, helium-leak test, and inspect.

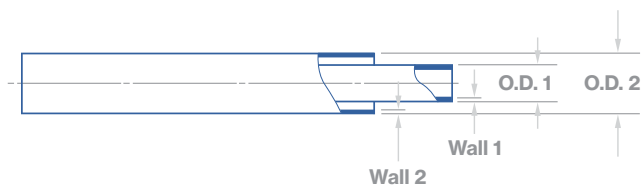

Coaxial Tube

ASTM A269 / A632

Product Lines				Dimensions in Inches							
401	301	201	101	Size	Inner Tube		Outer Tube		Weight per foot (lbs.)	Maximum Pressure*	
					O.D. 1	Wall 1	O.D. 2	Wall 2		PSI	Bar
●	●	●	●	1/4"	.250	.035	.500	.049	.32	2,509	173
●	●	●	●	1/4"	.250	.039	.500	.049	.33	2,509	173
●	●	●	●	3/8"	.375	.035	.625	.049	.43	1,981	137
●	●	●	●	3/8"	.375	.039	.625	.049	.44	1,981	137
●	●	●	●	1/2"	.500	.049	.750	.065	.72	2,207	152
●	●	●	●	3/4"	.750	.065	1.00	.065	1.13	1,631	113
●	●	●	●	1"	1.00	.065	1.25	.065	1.48	1,294	89
●	●	●	●	1-1/2"	1.50	.065	2.00	.065	2.36	796	55
●	●	●	●	2"	2.00	.065	2.50	.065	3.06	635	44

* Gauge pressure is listed.

Notes:

1. Maximum safe pressure calculated per ASME B 31.3-2014, paragraph 304.1.2 (formula 3a). Calculations assume maximum allowable O.D. and minimum allowable wall thickness (worst case scenario) for the outer jacket only.
2. Pressures listed in the chart above are based on welded outer jacket material. Inner tube and outer jacket tube material per ASTM A269 TP 304L or TP 316L.

Coaxial Tube

Hastelloy® C-22® Inner Tube
with Stainless Steel Outer Jacket

Product Line	Dimensions in Inches							
222	Size	Inner Tube		Outer Tube		Weight per foot (lbs.)	Maximum Pressure*	
		O.D. 1	Wall 1	O.D. 2	Wall 2		PSI	Bar
●	1/4"	.250	.035	.500	.049	.33	2,509	173
●	3/8"	.375	.035	.625	.049	.44	1,981	137
●	1/2"	.500	.049	.750	.065	.74	2,207	152

* Gauge pressure is listed.

Notes:

1. Maximum safe pressure calculated per ASME B 31.3-2014, paragraph 304.1.2 (formula 3a). Calculations assume maximum allowable O.D. and minimum allowable wall thickness (worst case scenario) for the outer jacket only.
2. Pressures listed in the chart above are based on welded outer jacket material per ASTM A269 TP 304L or TP 316L. Inner tube material is Hastelloy® C-22®, Hastelloy and C-22 are registered trademarks of Haynes International Inc.

CONFIGURATION
2

Coaxial 90° Elbow

Valex Standard, ASTM Tube

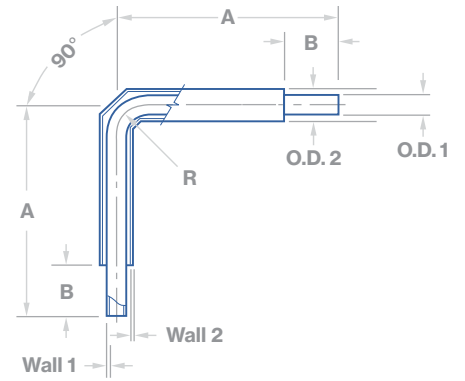

Product Lines		
401	201	222
•	•	•
•	•	•
•	•	•
•	•	
•	•	
•	•	
•	•	

Dimensions in Inches							
Size*	Inner Tube		Outer Tube		A	B	R
	O.D. 1	Wall 1	O.D. 2	Wall 2			
1/4"	.250	.035	.500	.049	4.375	1.00	.56
3/8"	.375	.035	.625	.049	4.125	1.00	.56
1/2"	.500	.049	.750	.065	4.250	1.00	.75
3/4"	.750	.065	1.000	.065	6.750	1.75	1.12
1"	1.000	.065	1.250	.065	7.125	1.75	1.50
1-1/2"	1.500	.065	2.000	.065	8.375	2.00	2.25
2"	2.000	.065	2.500	.065	9.000	2.00	3.00

* Size is based on o.d. of inner tube.

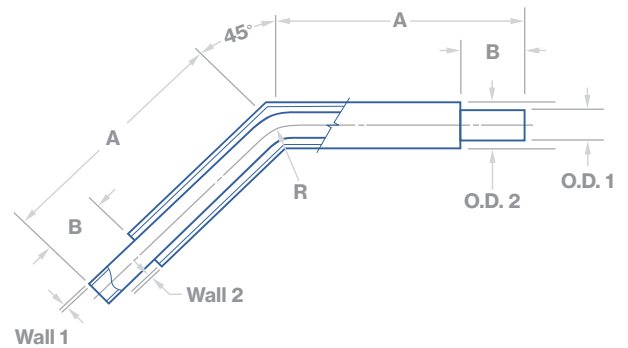

CONFIGURATION
2K

Coaxial 45° Elbow

Valex Standard, ASTM Tube

Product Lines		
401	201	222
•	•	•
•	•	•
•	•	•
•	•	
•	•	
•	•	

Dimensions in Inches							
Size*	Inner Tube		Outer Tube		A	B	R
	O.D. 1	Wall 1	O.D. 2	Wall 2			
1/4"	.250	.035	.500	.049	4.000	1.00	.56
3/8"	.375	.035	.625	.049	3.875	1.00	.56
1/2"	.500	.049	.750	.065	3.875	1.00	.75
3/4"	.750	.065	1.000	.065	6.125	1.75	1.12
1"	1.000	.065	1.250	.065	6.250	1.75	1.50
1-1/2"	1.500	.065	2.000	.065	7.120	2.00	2.25

* Size is based on o.d. of inner tube.

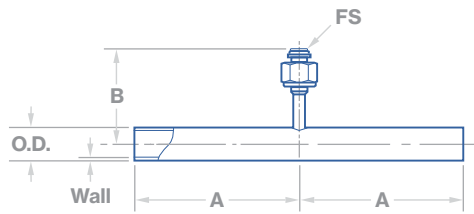

Dimensions



Coaxial Female Purge Tee

Valex Standard, ASTM Tube



Compatible with Product Lines			Dimensions in Inches					
401	201	222	Size*	O.D.	Wall	A	B	Face-Seal Size
●	●	●	1/4"	.500	.049	2.875	1.90	1/4"
●	●	●	3/8"	.625	.049	3.000	1.96	1/4"
●	●	●	1/2"	.750	.065	3.000	2.01	1/4"
●	●		3/4"	1.000	.065	4.625	2.14	1/4"
●	●		1"	1.250	.065	4.750	2.26	1/4"
●	●		1-1/2"	2.000	.065	5.625	2.64	1/4"
●	●		2"	2.500	.065	5.750	2.89	1/4"

* Size indicates inner tubing the purge tee is compatible with.

Note:
1. Purge tees are offered in grade TP 316L for all product lines.

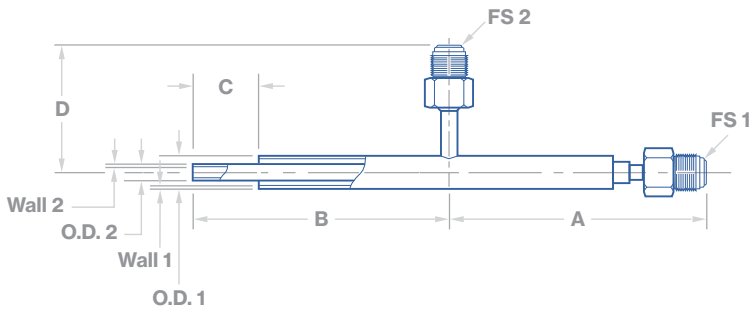

Coaxial Purge Tee With Male Face-Seal Gland

Valex Standard, ASTM Tube



Product Lines		Dimensions in Inches										
401	201	Size*	Inner Tube		Outer Tube		A	B	C	D	Face-Seal Size	
			O.D. 1	Wall 1	O.D. 2	Wall 2					FS 1	FS 2
●	●	1/4"	.250	.035	.500	.049	3.875	3.875	1.00	1.90	1/4"	1/4"
●	●	3/8"	.375	.035	.625	.049	4.000	4.000	1.00	1.96	3/8"	1/4"
●	●	1/2"	.500	.049	.750	.065	4.000	4.000	1.00	2.01	1/2"	1/4"

* Size is based on o.d. of inner tube.

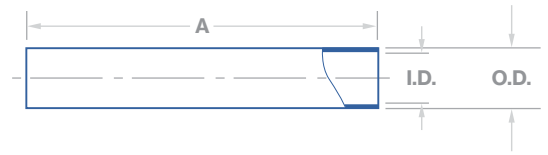

CONFIGURATION
12

Coaxial Sleeve

Valex Standard, ASTM Tube

Compatible with Product Lines		
401	201	222
●	●	●
●	●	●
●	●	●
●	●	●
●	●	●
●	●	●
●	●	●

Dimensions in Inches					
Size*	O.D.	I.D.	A (Standard Length)	A (Additional Lengths)	
1/4"	.625	.507	2.50	4.00 / 5.00 / 6.00	
3/8"	.750	.632	2.50	4.00 / 5.00 / 6.00	
1/2"	.875	.758	2.50	4.00 / 5.00 / 6.00	
3/4"	1.125	1.008	4.00	4.00 / 5.00 / 6.00	
1"	1.375	1.258	4.00	N/A	
1-1/2"	2.125	2.023	4.50	N/A	
2"	2.625	2.523	4.50	N/A	

* Sleeve size indicates the size of coax tubing the sleeve is compatible with.

Note:
1. Sleeves are offered in grade TP 316L for all product lines.

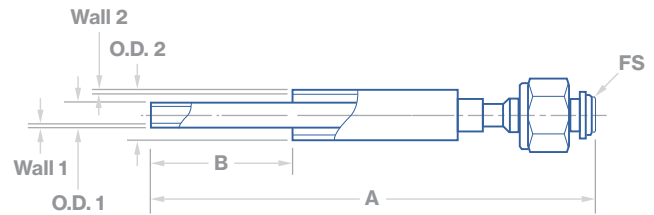

CONFIGURATION
14FS

Coaxial Female Face-Seal Weld Gland

Valex Standard, ASTM Tube

Product Lines	
401	201
●	●
●	●
●	●

Dimensions in Inches							
Size*	Inner Tube		Outer Tube		A	B	Face-Seal Size FS
	O.D. 1	Wall 1	O.D. 2	Wall 2			
1/4"	.250	.035	.500	.049	3.50	.850 - 1.060	1/4"
3/8"	.375	.035	.625	.049	3.50	.850 - 1.060	3/8"
1/2"	.500	.049	.750	.065	3.50	.850 - 1.060	1/2"

* Size is based on o.d. of inner tube.

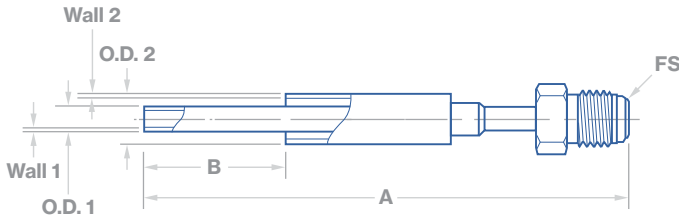

Coaxial Male Face-Seal Weld Gland

Valex Standard, ASTM Tube

CONFIGURATION
15FS

Product Lines	
401	201
●	●
●	●
●	●

Dimensions in Inches							
Size*	Inner Tube		Outer Tube		A	B	Face-Seal Size
	O.D. 1	Wall 1	O.D. 2	Wall 2			FS
1/4"	.250	.035	.500	.049	3.50	.850 - 1.060	1/4"
3/8"	.375	.035	.625	.049	3.50	.850 - 1.060	3/8"
1/2"	.500	.049	.750	.065	3.50	.850 - 1.060	1/2"

* Size is based on o.d. of inner tube.

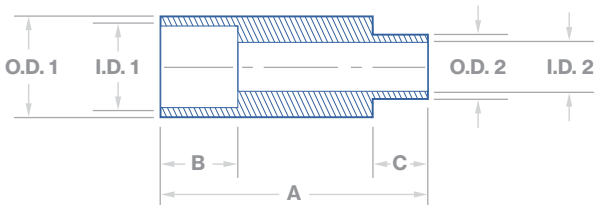

Coaxial Terminator

Valex Standard, ASTM Tube

CONFIGURATION
16

Compatible with Product Lines		
401	201	222
●	●	●
●	●	●
●	●	●
●	●	
●	●	
●	●	
●	●	

Dimensions in Inches								
Size*	O.D. 1	I.D. 1	O.D. 2	I.D. 2	A	B	C	
1/4"	.500	.402	.325	.255	1.25	.37	.25	
3/8"	.625	.527	.450	.380	1.25	.37	.25	
1/2"	.750	.620	.603	.506	1.25	.37	.25	
3/4"	1.000	.870	.885	.756	2.00	.50	.25	
1"	1.250	1.120	1.135	1.006	2.00	.50	.25	
1-1/2"	2.000	1.870	1.635	1.511	2.25	.75	.25	
2"	2.500	2.360	2.135	2.011	2.25	.75	.25	

* Terminator size indicates the size of coax tubing the terminator is compatible with.

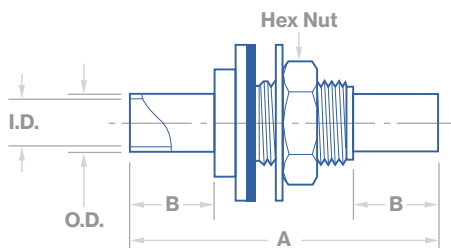

Coaxial Bulkhead Fitting

Valex Standard, ASTM Tube

CONFIGURATION
17BH

Compatible with Product Lines		
401	201	222
●	●	●
●	●	●
●	●	●
●	●	
●	●	

Dimensions in Inches					
Size*	O.D.	I.D.	A	B	Hex Nut
1/4"	.500	.402	3.625	1.00	3/4-16UNF
3/8"	.625	.527	3.625	1.00	7/8-14UNF
1/2"	.750	.620	3.625	1.00	1-1/16-12UNF
3/4"	1.000	.870	5.125	1.75	1-5/16-12UNF
1"	1.250	1.120	5.125	1.75	1-5/8-12UNF

* Bulkhead fitting size indicates the size of coax tubing the bulkhead fitting is compatible with.
Note: Bulkhead fittings are offered in grade TP 316L for all product lines.

Ordering Info.

Tube & Pipe

- ASTM Tube Sizes
- JIS Pipe Sizes
- ASTM Tube, ASTM Pipe & JIS Pipe Sizes

Fittings

- ASTM Tube Sizes
- JIS Pipe Sizes
- ASTM Tube, ASTM Pipe & JIS Pipe Sizes

Coaxial Tube & Fittings

- ASTM Tube Sizes

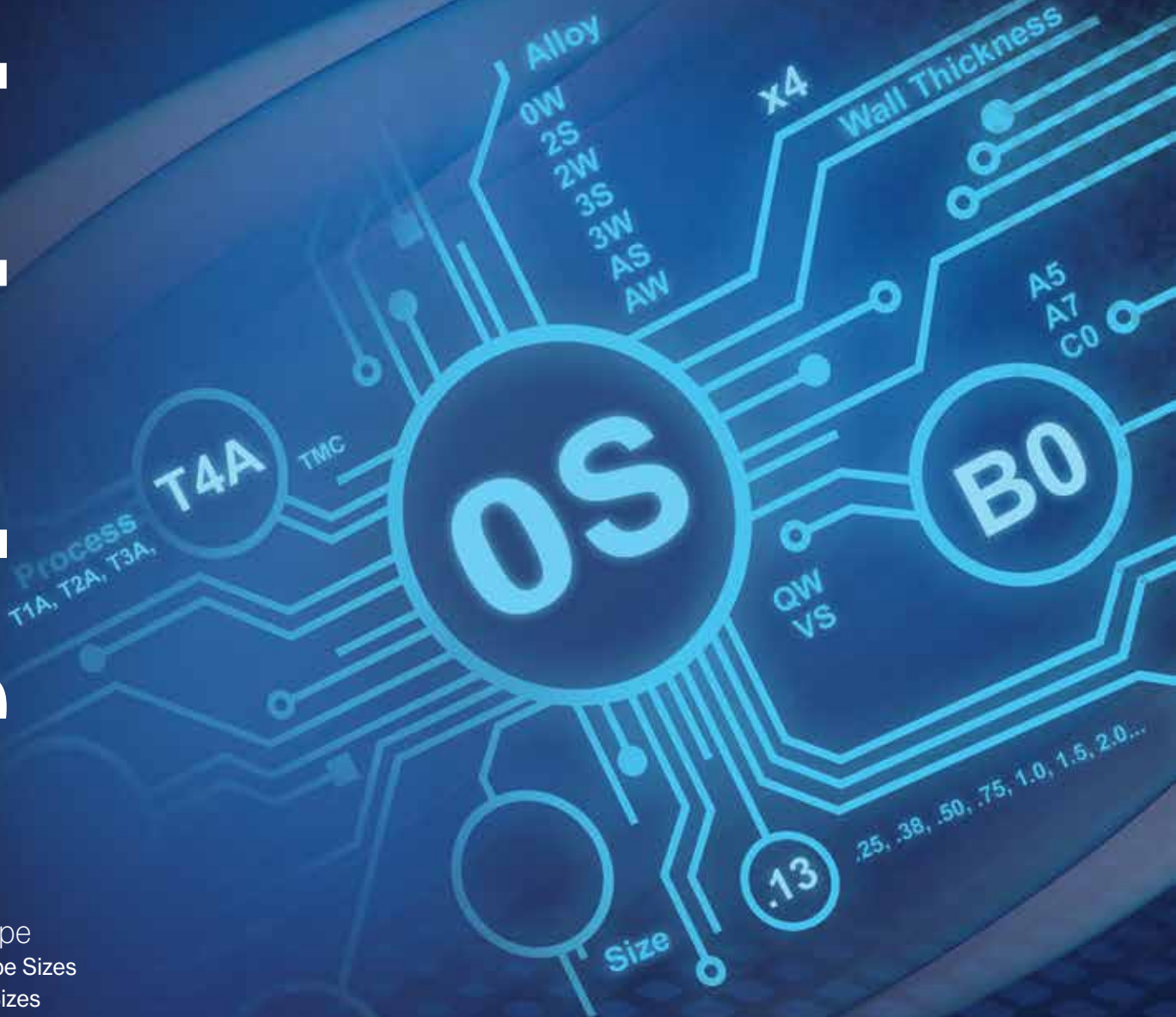



Tube

Product Lines: 401, 301, 201, 101 & 222

ASTM Tube Sizes

Example 1:

T 4 A - Q S - . 1 3 x4 - 0 2 8 B 0

Use Only for 4-meter Length Tube

Example 2:

T 2 A - 0 S - 0 0 5 0 0 - 0 4 9

T 4 A

Process

- T1A = SP-9204 (Product Line 101)
- T2A = SP 9206 (Product Line 201)
- T3A = SP-9223 (Product Line 301)
- T4A = SP-9220 (Product Line 401)
- TMC = SP-9207 (Product Line 222)

Q S

Alloy¹

- 0S = 316L Seamless
- 0W = 316L Welded
- 2S = 304L Seamless
- 2W = 304L Welded
- 3S = 304L Seamless
- 3W = 304L Welded
- AS = 304 Seamless
- AW = 304 Welded
- HS = Hastelloy® C-22* (Seamless)*
- KS = 316L Seamless VIM/VAR
- NS = 316L Seamless (ASTM Standard)
- NW = 316L Welded (ASTM Standard)
- OS = 316L Seamless
- QW = 316L Welded
- VS = 316L Seamless VIM/VAR

. 1 3

Size

	Use for:	
	20-foot & 6-meter Length Tube	4-meter Length Tube
00125	.13	= .125" Diameter
00250	.25	= .25" Diameter
00375	.38	= .375" Diameter
00500	.50	= .5" Diameter
00750	.75	= .75" Diameter
01000	1.0	= 1" Diameter
01500	1.5	= 1.5" Diameter
02000	2.0	= 2" Diameter
02500	2.5	= 2.5" Diameter
03000	3.0	= 3" Diameter
04000	4.0	= 4" Diameter
06000	6.0	= 6" Diameter

x4

Used Only
for 4-meter Length Tube

0 2 8

Wall Thickness

- 028 = .028" Thick
- 035 = .035" Thick
- 039 = .039" Thick
- 049 = .049" Thick
- 065 = .065" Thick
- 083 = .083" Thick
- 109 = .109" Thick

B 0

Surface Finish & Visuals

Used only for 401 product line

- A5 = 5µin Ra Max, Superior Visuals
- A7 = 7µin Ra Max, Superior Visuals
- B0 = 10µin Ra Max, Standard Visuals
- C0 = 10µin Ra, Relaxed Visuals

Notes:

- * ® HASTELLOY and C-22 are registered trademarks of Haynes International Inc.
- 1. See Valex SP-9200 sheet 9 for breakdown of alloy chemistries and melt type.

Pipe

Product Lines: 401, 201 & 101

JIS Pipe Sizes

Example 1:

P 4 A - R S - 0 5 0 A x4 - 0 5 S B 0

Use Only for 4-meter Length Pipe

Example 2:

P 2 A - R S - 0 1 5 0 A - 1 0 S

P 4 A

Process

- P1A = SP-9204 (Product Line 101)
- P2A = SP 9206 (Product Line 201)
- P4A = SP-9220 (Product Line 401)

R S

Alloy¹

- 1S = 304L Seamless (JIS Standard)
- 1W = 304L Welded (JIS Standard)
- AS = 304 Seamless
- AW = 304 Welded
- BS = 316L Seamless, VOD/VAR
- NS = 316L Seamless (JIS Standard)
- NW = 316L Welded (JIS Standard)
- RS = 316L Seamless
- RW = 316L Welded

0 5 0

Size

Use for:
 20-foot & 6-meter Length Pipe | 4-meter Length Pipe

0008	008	= 8A Pipe
0010	010	= 10A Pipe
0015	015	= 15A Pipe
0020	020	= 20A Pipe
0025	025	= 25A Pipe
0032	032	= 32A Pipe
0040	040	= 40A Pipe
0050	050	= 50A Pipe
0065	065	= 65A Pipe
0080	080	= 80A Pipe
0090	090	= 90A Pipe
0100	100	= 100A Pipe
0125	125	= 125A Pipe
0150	150	= 150A Pipe
0200	200	= 200A Pipe
0250	250	= 250A Pipe
0300	300	= 300A Pipe
0350	350	= 350A Pipe
0400	400	= 400A Pipe
0450	450	= 450A Pipe
0500	500	= 500A Pipe
0550	550	= 550A Pipe
0600	600	= 600A Pipe

A

End Type

- A = Square
- B = 32.5° Beveled
- C = Square, +10% / -15% Wall
- D = 32.5° Beveled, +10% / -15% Wall

x4

Used Only for 4-meter Length Pipe

0 5 S

Schedule

6m Pipe:

- 05S = JIS Schedule 5
- 10S = JIS Schedule 10

4m Pipe:

- 05 = JIS Schedule 5
- 10 = JIS Schedule 10

B 0

Surface Finish & Visuals

Used only for 401 product line

- A5 = 5µin Ra Max, Superior Visuals
- A7 = 7µin Ra Max, Superior Visuals
- B0 = 10µin Ra Max, Standard Visuals
- C0 = 10µin Ra, Relaxed Visuals

Notes:

1. See Valex SP-9200 sheet 9 for breakdown of alloy chemistries and melt type.



Tube & Pipe

Product Lines: CFOS & LDEP

ASTM Tube, ASTM Pipe & JIS Pipe Sizes

Example :

D **W** - **1** **5** **0** **L** x **1** **0** **S** - **B** **A** **4** **0**

D | W

Process / Alloy

CS = 316L Seamless
 CW = 316L Welded
 DS = 304L Seamless
 DW = 304L Welded
 AS = 304 Seamless
 AW = 304 Welded

1 | 5 | 0

Size

ASTM Tube:

1/4 = .25" Diameter
 3/8 = .375" Diameter
 1/2 = .5" Diameter
 3/4 = .75" Diameter
 1 = 1" Diameter
 1-1/2 = 1.5" Diameter
 2 = 2" Diameter
 2-1/2 = 2.5" Diameter
 3 = 3" Diameter
 4 = 4" Diameter
 6 = 6" Diameter

JIS & NPS Pipe:

25 = DN 25 (JIS 25A)
 32 = DN 32 (JIS 32A)
 40 = DN 40 (JIS 40A)
 50 = DN 50 (NPS 2 / JIS 50A)
 65 = DN 65 (NPS 2-1/2 / JIS 65A)
 80 = DN 80 (NPS 3 / JIS 80A)
 90 = DN 90 (NPS 3-1/2 / JIS 90A)
 100 = DN 100 (NPS 4 / JIS 100A)
 125 = DN 125 (NPS 5 / JIS 125A)
 150 = DN 150 (NPS 6 / JIS 150A)
 200 = DN 200 (NPS 8 / JIS 200A)
 250 = DN 250 (NPS 10 / JIS 250A)

300 = DN 300 (NPS 12 / JIS 300A)
 350 = DN 350 (NPS 14 / JIS 350A)
 400 = DN 400 (NPS 16 / JIS 400A)
 450 = DN 450 (NPS 18 / JIS 450A)
 500 = DN 500 (NPS 20 / JIS 500A)
 550 = DN 550 (NPS 22 / JIS 550A)
 600 = DN 600 (NPS 24 / JIS 600A)
 650 = DN 650 (JIS 650A)
 700 = DN 700 (JIS 700A)
 750 = DN 750 (NPS 30 / JIS 750A)

L

End Type

ASTM Tube:

Blank = Square

JIS Pipe:

A = Square
 B = Beveled
 J = Square, -20% Wall
 K = Beveled, -20% Wall

NPS Pipe:

L = Square
 M = Beveled
 N = Square, -20% Wall
 P = Beveled, -20% Wall

1 | 0 | S

Wall Thickness

Tube Wall:

.035 = .035" Thick
 .039 = .039" Thick
 .049 = .049" Thick
 .065 = .065" Thick
 .083 = .083" Thick
 .109 = .109" Thick

Pipe Schedule:

5S = Schedule 5
 10S = Schedule 10
 40S = Schedule 40
 80S = Schedule 80

B | A | 4 | 0

Surface Finish

AP = CFOS, O.D. = AP, I.D. = AP
 BA = CFOS, O.D. = BA, I.D. = BA
 BA40 = CFOS, O.D. = BA, I.D. = 40 Ra BA
 EP = LDEP, O.D. = BA, I.D. = EP
 20 Ra Ave / 25 Ra Max
 ID40 = CFOS, O.D. = AP, I.D. = 40 Ra BA
 IDMP = CFOS, O.D. = AP, I.D. = BA

ASTM Tube Example:

CS-1/2x.049-BA

Valex CFOS Spec Tube, 316L Seamless, 1/2" O.D. x .049" Wall, BA Finish Option, Squared Ends

JIS Pipe Example:

AW-250BX10S-AP

Valex CFOS Spec Pipe, 304 Welded, JIS Size 250A x Schedule 10, AP Finish Option, Beveled Ends

NPS Pipe Example:

DW-250LX20S-BA40

Valex CFOS Spec Pipe, 304L Welded, NPS 10 (DN 250) x Schedule 20, BA Finish Option with 40 Ra, Squared Ends

Fittings

Product Lines: 401, 201 & 222

ASTM Tube Sizes

Example:

E **7 R** - **. 7 5** x (**. 5**) - **B 0**

Used Only for Reducing Fittings

E

Process / Alloy¹

- B = SP-9206 (Product Line 201) 0S/0W/A4 (316L)
- D = SP-9206 (Product Line 201) 2S/2W (304L)
- E = SP-9220 (Product Line 401) 0S/0W/A4 (316L)
- H = SP-9207 (Product Line 222) HS (Hastelloy® C-22)*
- Q = SP-9220 (Product Line 401) VS (316L)
- RB = SP-9206 (Product Line 201) RS/RW (316L)
- RE = SP-9220 (Product Line 401) RS/RW (316L)

7 R

Configuration

- 2 = 90° Elbow
- 2W = 90° Elbow, WLD
- 2K = 45° Elbow
- 2KW = 45° Elbow, WLD
- 7 = Equal Tee
- 7W = Equal Tee, WLD
- 7R = Reducing Tee
- 7RW = Reducing Tee, WLD
- 7RWW = Reducing Tee, WLD x WLD
- 9 = Cross
- 16 = End Cap
- 16W = End Cap, WLD
- 31 = Conc. Reducer
- 31(S) = Conc. Reducer, Short Type
- 31W = Conc. Reducer, WLD x SMLS
- 31WW = Conc. Reducer, WLD x WLD
- 38 = Weld Neck Flange w/ SMLS Tube
- 38W = Weld Neck Flange w/ WLD Tube
- 38SE = Tube Stub End, Short
- 38LE = Tube Stub End, Long
- 38PF = Tube Plate Flange

. 7 5

Size

- .25 = 1/4" O.D. x .035" Wall
- .25M = 1/4" O.D. x .039" (1mm) Wall
- .375 = 3/8" O.D. x .035" Wall
- .375M = 3/8" O.D. x .039" (1mm) Wall
- .5 = 1/2" O.D. x .049" Wall
- .75 = 3/4" O.D. x .065" Wall
- .75M = 3/4" O.D. x .049" Wall
- 1 = 1" O.D. x .065" Wall
- 1.5 = 1-1/2" O.D. x .065" Wall
- 2 = 2" O.D. x .065" Wall
- 2.5 = 2-1/2" O.D. x .065" Wall
- 3 = 3" O.D. x .065" Wall
- 4 = 4" O.D. x .083" Wall
- 6 = 6" O.D. x .109" Wall

(**. 5**)

Used Only for Reducing Fittings

Please refer to "size" code if applicable.

B 0

Surface Finish & Visuals

Used only for 401 product line

- A5 = 5µin Ra Max, Superior Visuals
- A7 = 7µin Ra Max, Superior Visuals
- B0 = 10µin Ra Max, Standard Visuals
- C0 = 10µin Ra, Relaxed Visuals

Single Wall Fitting Example 1:

E2-5-B0

Valex 401 Spec, 90° Elbow, 1/2" O.D. x .049" Wall, 10 Ra Max, 0S Chemistry, Standard Visuals

Single Wall Fitting Example 2:

Q7R-1x.5-A5

Valex 401 Spec, Reducing Tee, 1" (.065" Wall) x 1/2" (.049" Wall), 5 Ra Max, VS Chemistry, Superior Visuals

Notes:

- * © HASTELLOY and C-22 are registered trademarks of Haynes International Inc.
- 1. See Valex SP-9200 sheet 9 for breakdown of alloy chemistries and melt type.



Fittings

Product Lines: 401, 201 & 101

JIS Pipe Sizes

Example:

J E **7 R W** - **8 0** **A T** x (**4 0 A T**) - **B 0**

Used Only for Reducing Fittings

J | E

Process / Alloy¹

- JA = SP-9204 (Product Line 101) AS/AW (304)
- JB = SP-9206 (Product Line 201) RS/RW (316L)
- JD = SP-9206 (Product Line 201) AS/AW (304)
- JE = SP-9220 (Product Line 401) RS/RW (316L)

7 | R | W

Configuration

- 2S = 90° Elbow, Short Radius
- 2L = 90° Elbow, Long Radius
- 2WS = 90° Elbow, Short Radius, WLD
- 2WL = 90° Elbow, Long Radius, WLD
- 2K = 45° Elbow
- 2KW = 45° Elbow, WLD
- 2SS = 90° Elbow, Short, JIS B2312
- 2LS = 90° Elbow, Long, JIS B2312
- 2WSS = 90° Elbow, Short, JIS B2312, WLD
- 2WLS = 90° Elbow, Long, JIS B2312, WLD
- 2KLS = 45° Elbow, Long, JIS B2312
- 2KWLS = 45° Elbow, Long, JIS B2312, WLD
- 7 = Equal Tee
- 7W = Equal Tee, WLD
- 7R = Reducing Tee
- 7RW = Reducing Tee, WLD
- 7RWW = Reducing Tee, WLD x WLD
- 7S = Equal Tee, JIS B2312
- 7RS = Reducing Tee, JIS B2312
- 16 = End Cap
- 16W = End Cap, WLD
- 31 = Conc. Reducer
- 31W = Conc. Reducer, WLD x SMLS
- 31WW = Conc. Reducer, WLD x WLD
- 33 = Cap Reducer
- 38BF = Blank Flange
- 38L = Lap Joint Stub End, JIS
- 38LJ = Lap Joint Flange
- 38WN = Weld Neck Flange

8 | 0

Size

- 8 = 8A Pipe
- 10 = 10A Pipe
- 15 = 15A Pipe
- 20 = 20A Pipe
- 25 = 25A Pipe
- 32 = 32A Pipe
- 40 = 40A Pipe
- 50 = 50A Pipe
- 65 = 65A Pipe
- 80 = 80A Pipe
- 90 = 90A Pipe
- 100 = 100A Pipe
- 125 = 125A Pipe
- 150 = 150A Pipe
- 200 = 200A Pipe
- 250 = 250A Pipe
- 300 = 300A Pipe
- 350 = 350A Pipe
- 400 = 400A Pipe
- 450 = 450A Pipe
- 500 = 500A Pipe
- 550 = 550A Pipe
- 600 = 600A Pipe

A

End Type

- A = Square
- B = 32.5° Beveled
- C = Square, +10% / -15% Wall
- D = 32.5° Beveled, +10% / -15% Wall

Flange Type

- S = JIS 5K
- T = JIS 10K

T

Schedule

- Blank = 5S
- T = 10S

Face-Type (Flange Only)

- 1 = Full Face
- 2 = Raised Face
- 3 = Grooved Face

(4 | 0 | A | T)

Used Only for Reducing Fittings

Please refer to the "size, end type and schedule" codes if applicable.

B | 0

Surface Finish & Visuals

Used only for 401 product line

- A5 = 5µin Ra Max, Superior Visuals
- A7 = 7µin Ra Max, Superior Visuals
- B0 = 10µin Ra Max, Standard Visuals
- C0 = 10µin Ra, Relaxed Visuals

Notes:

1. See Valex SP-9200 sheet 9 for breakdown of alloy chemistries and melt type.

Fittings

Product Lines: CFOS & LDEP

ASTM Tube, ASME Pipe & JIS Pipe Sizes

Example:

D F **7 R W** - **8 4** **P T** (**8 1 P T**) - **1**

Used Only for Reducing Fittings

D | F

Alloy

AF = 304
CF = 316L
DF = 304L

7 | R | W

Configuration

2S = 90° Elbow, Short Radius
2L = 90° Elbow, Long Radius
2WS = 90° Elbow, Short Radius, WLD
2WL = 90° Elbow, Long Radius, WLD
2K = 45° Elbow
2KW = 45° Elbow, WLD
2SS = 90° Elbow, Short, ASME B16.9 / JIS B2312
2LS = 90° Elbow, Long, ASME B16.9 / JIS B2312
2WSS = 90° Elbow, Short, ASME B16.9 / JIS B2312, WLD
2WLS = 90° Elbow, Long, ASME B16.9 / JIS B2312, WLD
2KLS = 45° Elbow, Long, ASME B16.9 / JIS B2312
2KWLS = 45° Elbow, Long, ASME B16.9 / JIS B2312, WLD
7 = Equal Tee
7W = Equal Tee, WLD
7R = Reducing Tee
7RW = Reducing Tee, WLD
7RWW = Reducing Tee, WLD x SMLS
7S = Equal Tee, JIS B2312
7RS = Reducing Tee, JIS B2312
9 = Equal Cross
16 = End Cap
16W = End Cap, WLD
31 = Conc. Reducer
31W = Conc. Reducer, WLD x SMLS
31WW = Conc. Reducer, WLD x WLD
33 = Cap Reducer
38BF = Blind / Blank Flange
38L = Lap Joint Stub End, JIS
38LA = Lap Joint Stub End, Long Pattern, Type "A", ASME B16.9
38SA = Lap Joint Stub End, Short Pattern, Type "A", ASME B16.9
38LJ = Lap Joint Flange
38WN = Weld Neck Flange

8 | 4

Size

ASTM Tube:

04 = .25" Diameter	32 = 2" Diameter
06 = .375" Diameter	40 = 2.5" Diameter
08 = .5" Diameter	48 = 3" Diameter
12 = .75" Diameter	64 = 4" Diameter
16 = 1" Diameter	96 = 6" Diameter
24 = 1.5" Diameter	

JIS & NPS Pipe:

70 = DN 15 (NPS 1/2 / JIS 15A)
71 = DN 20 (NPS 3/4 / JIS 20A)
72 = DN 25 (NPS 1 / JIS 25A)
73 = DN 32 (NPS 1-1/4 / JIS 32A)
74 = DN 40 (NPS 1-1/2 / JIS 40A)
75 = DN 50 (NPS 2 / JIS 50A)
76 = DN 65 (NPS 2-1/2 / JIS 65A)
77 = DN 80 (NPS 3 / JIS 80A)
78 = DN 90 (NPS 3-1/2 / JIS 90A)
79 = DN 100 (NPS 4 / JIS 100A)
80 = DN 125 (NPS 5 / JIS 125A)
81 = DN 150 (NPS 6 / JIS 150A)
82 = DN 200 (NPS 8 / JIS 200A)
83 = DN 250 (NPS 10 / JIS 250A)
84 = DN 300 (NPS 12 / JIS 300A)
85 = DN 350 (NPS 14 / JIS 350A)
86 = DN 400 (NPS 16 / JIS 400A)
87 = DN 450 (NPS 18 / JIS 450A)
88 = DN 500 (NPS 20 / JIS 500A)
89 = DN 550 (NPS 22 / JIS 550A)
90 = DN 600 (NPS 24 / JIS 600A)

P

Type Code

ASTM Tube:

Blank = Square

JIS Pipe:

A = Square
B = Beveled
J = Square, -20% Wall
K = Beveled, -20% Wall

NPS Pipe:

L = Square
M = Beveled
N = Square, -20% Wall
P = Beveled, -20% Wall

Flange Type:

Q = Class 150, B16.5
S = JIS B2220, 5K
T = JIS B2220, 10K

T

Wall

ASTM Tube:

B = .035" Wall
C = .039" Wall
D = .049" Wall
F = .065" Wall
G = .083" Wall
J = .109" Wall

JIS & NPS Pipe:

Blank = 5S
T = 10S
V = 40S
W = 80S

Flange Type (Flange Only):

1 = Flat / Full Face
2 = Raised Face
3 = Grooved Face

(8 | 1 | P | T)

Used Only for Reducing Fittings

Please refer to "size, end type and wall" codes if applicable.

1

Finish Code

Blank = No Finish Requirement
1 = CFOS, O.D. = AP, I.D. = AP
2 = CFOS, O.D. = BA, I.D. = BA
3 = CFOS, O.D. = BA, I.D. = 40 Ra BA
4 = LDEP, O.D. = BA, I.D. = EP 20 Ra Ave / 25 Ra Max
5 = CFOS, O.D. = AP, I.D. = 40 Ra BA
6 = CFOS, O.D. = AP, I.D. = BA

Fitting Example 1:

CF31W-82PT81PT-4

Valex LDEP Spec, Concentric Reducer, NPS 8 (Sch 10) x NPS 6 (Sch 10), 20 Ra, EP, 316L



Coaxial Tube

Product Lines: 401, 301, 201, 101 & 222

ASTM Tube Sizes

Example:

C T 4 A - W - V S - . 3 7 5 x4 - A 5

Use Only for 4-meter Length Tube

C | T | 4 | A

Inner Process

- CT1A = SP-9204 (Product Line 101)
- CT2A = SP-9206 (Product Line 201)
- CT3A = SP-9223 (Product Line 301)
- CT4A = SP-9220 (Product Line 401)
- CTMC = Per SP-9207 (Product Line 222)

W

Outer Alloy¹

- S = 316L 0S Seamless
- W = 316L 0W Welded
- 2S = 304L Seamless
- 2W = 304L Welded
- AW = 304 Welded
- NS = 316L Seamless (ASTM Standard)
- RS = 316L Seamless
- RW = 316L Welded

V | S

Inner Alloy¹

- 0S = 316L Seamless
- 0W = 316L Welded
- 2S = 304L Seamless
- 2W = 304L Welded
- 3S = 304L Seamless
- 3W = 304L Welded
- HS = Hastelloy® C-22® (Seamless)*
- KS = 316L Seamless VIM/VAR
- NS = 316L Seamless (ASTM Standard)
- NW = 316L Welded (ASTM Standard)
- QS = 316L Seamless
- QW = 316L Welded
- RS = 316L Seamless
- RW = 316L Welded (JIS Standard)
- VS = 316L Seamless VIM/VAR

. | 3 | 7 | 5 (X | X | X | X)

Inner Size

Use for:

20-foot & 6-meter Length Tube	4-meter Length Tube	
.25	.25	= .25" Diameter
.25M	.25M	= .25" Diameter (1mm Wall)
.375	.38	= .375" Diameter
.375M	.38M	= .375" Diameter (1mm Wall)
.5	.5	= .5" Diameter
.75	.75	= .75" Diameter
1	1	= 1" Diameter
1.5	1.5	= 1.5" Diameter
2	2	= 2" Diameter

x4

Used Only for 4-Meter Length Tube

A | 5

Surface Finish & Visuals

Used only for 401 product line

- A5 = 5µin Ra Max, Superior Visuals
- A7 = 7µin Ra Max, Superior Visuals
- B0 = 10µin Ra Max, Standard Visuals
- C0 = 10µin Ra, Relaxed Visuals

Notes:

1. See Valex SP-9200 sheet 9 for breakdown of alloy chemistries and melt type.

Coaxial Fittings

ASTM Tube Sizes ■ Product Lines: 401, 201 & 222

Example:

C **3 1** - **. 5** x (**. 2 5**) - **B 0**

Use Only for Reducing Fittings

C

Inner Process / Alloy¹

- C = SP-9220 (Product Line 401) OS/OW (316L)
- CB = SP-9206 (Product Line 201) OS/OW (316L)
- HC = SP-9207 (Product Line 222) HS (Hastelloy® C-22*)
- R = SP-9220 (Product Line 401) VS (316L)
- RC = SP-9220 (Product Line 401) RS/RW (316L)
- W = SP-9220 (Product Line 401) KS (316L)

Outer Alloy¹

- Blank = OS/OW (316L)
- 2 = 2S/2W (304L)
- A = AW (304)
- N = NS (316L)
- R = RS/RW (316L)

3 1

Configuration

- 2 = 90° Elbow
- 2K = 45° Elbow
- 7 = Equal Tee
- 7R = Reducing Tee
- 7P = Coax Purge Tee, Male
- 7PF = Coax Purge Tee, Female
- 7PFS = Coax Purge Tee w/ FS, Male
- 12 = Coax Sleeve
- 14FS = Coax FS Weld Gland, Female
- 15FS = Coax FS Weld Gland, Male
- 16 = Coax Terminator
- 17BH = Coax Bulkhead Fitting
- 31 = Concentric Reducer

. 5

Size

- .25 = 1/4" O.D. x .035" Wall Inner Tube
1/2" O.D. x .049" Wall Outer Tube
- .25M = 1/4" O.D. x .039" (1mm) Wall Inner Tube
1/2" O.D. x .049" Wall Outer Tube
- .375 = 3/8" O.D. x .035" Wall Inner Tube
5/8" O.D. x .049" Wall Outer Tube
- .375M = 3/8" O.D. x .039" (1mm) Wall Inner Tube
5/8" O.D. x .049" Wall Outer Tube
- .5 = 1/2" O.D. x .049" Wall Inner Tube
3/4" O.D. x .065" Wall Outer Tube
- .75 = 3/4" O.D. x .065" Wall Inner Tube
1" O.D. x .065" Wall Outer Tube
- .75M = 3/4" O.D. x .049" Wall Inner Tube
1" O.D. x .065" Wall Outer Tube
- 1 = 1" O.D. x .065" Wall Inner Tube
1-1/4" O.D. x .065" Wall Outer Tube
- 1.5 = 1-1/2" O.D. x .065" Wall Inner Tube
2" O.D. x .065" Wall Outer Tube
- 2 = 2" O.D. x .065" Wall Inner Tube
2-1/2" O.D. x .065" Wall Outer Tube

(**. 2 5**)

Used Only

for Reducing Fittings

Please refer to the size code for dimensions, if applicable.

B 0

Surface Finish & Visuals

Used only for 401 product line

- A5 = 5µin Ra Max, Superior Visuals
- A7 = 7µin Ra Max, Superior Visuals
- B0 = 10µin Ra Max, Standard Visuals
- C0 = 10µin Ra, Relaxed Visuals

Coaxial Fitting Example 1:

C2-.25-A5

Valex 401 Spec, Coaxial 90° Elbow, 1/4" (.035" wall) Inner, 1/2" (.049" Wall) Outer, Superior Visuals, 5 Ra Max, OS Inner Chemistry, OS Outer Chemistry.

Notes:

- * © HASTELLOY and C-22 are registered trademarks of Haynes International Inc.
- 1. See Vallex SP-9200 sheet 9 for breakdown of alloy chemistries and melt type.



Benefit From World Leadership

World class components from Valex don't just end at tube, pipe and fittings. Our product offerings extend to ball valves, instrumentation valves, headers, manifolds, and more. For more information, please visit our website at www.valex.com, or contact your Valex representative for details. Benefit from world leadership, and benefit from Valex.



Valex Corporate Offices & Manufacturing

6080 Leland Street
Ventura, CA 93003
Phone: 805-658-0944

32 Hansan-Gil
Chungbuk-Myon
Pyongtaek-City
Kyonggi Province, Korea
Phone: 82-31-683-0119

No. 559 Yuanzhong Road
Nanhui Industrial Zone
Pudong New District
Shanghai, China 201399
Phone: 86-21-58183189